

ANBAUANLEITUNG

mounting instructions • instructions de montage • instrucciones de montaje • istruzioni di montaggio

ADV.22.995.76002

beinhaltet • contains • contient • contiene • contiene

SBL.22.995.10002/B

MSS.22.995.10000/B

HDG.00.220.80602/B

HDG.00.220.10300/B

STP.22.176.10302/B

STP.22.176.10001/B

Item number: **SBL.22.995.10002/B**

Revision: **00** · Date: **03 - 2024**

Crash bar

 ~ 1 h.

EASY     DIFFICULT

ENGLISH Thank you for choosing this premium product from SW-MOTECH. Visit our online shop for more information (e.g. model assignments). Required documents (e.g. national type approval) are available there for you to download.

Please read and understand all the instructions, safety information and warnings in these mounting instructions before mounting and using the product in order to avoid injury and damage. Keep these mounting instructions for reference.

This product was developed for vehicles in factory condition. Compatibility with original accessories or accessories from other manufacturers cannot be guaranteed.

These mounting instructions have been prepared to the best of our current knowledge. No legal claims relating to accuracy can be made. Errors and omissions excepted. We reserve the right to make technical and design changes. The copyright is held by SW-MOTECH.

SAFETY WARNING SYMBOL

 This warning symbol is used in these mounting instructions to warn of deadly dangers, injuries or other hazards. The words **DANGER, WARNING or CAUTION** are used as part of this warning symbol to convey important safety messages and information relating to the installation and use of this product. These words, together with the safety warning symbol, mean:

 **DANGER:** Indicates a hazardous situation which, if not avoided, will result in death or serious injury!

 **WARNING:** Indicates a hazardous situation which, if not avoided, may result in death or serious injury!

 **CAUTION:** Indicates a hazardous situation which, if not avoided, may result in minor or moderate injury!

 **NOTE:** Important information, but not relating to a risk of death or injury (property damage only)!

GENERAL INFORMATION

 **WARNING:** Assembly and/or maintenance of this product requires advanced technical skill, appropriate tools, and a good understanding of tool usage and torque specifications. For your own safety, SW-MOTECH recommends having the assembly and/or maintenance carried out by a qualified and certified motorcycle workshop.

 **WARNING:** If you do choose to assemble this product yourself, carefully and fully read the mounting instructions before assembly and use, and follow all instructions to avoid serious injury or death. Also observe all relevant information in the vehicle manual when mounting or using the product. **IF YOU DO NOT UNDERSTAND ANY PART OF THESE MOUNTING INSTRUCTIONS OR NEED AN EXPLANATION AS TO A SPECIFIC INSTRUCTION, DO NOT ATTEMPT TO INSTALL THIS PRODUCT WITHOUT CONSULTING SW-MOTECH FOR ASSISTANCE!**

PREPARATION: Read the mounting instructions carefully and make sure that all parts on the parts list are available.

 **CAUTION:** Ensure that your vehicle is standing securely. Switch off the engine and remove the ignition key. Allow the engine/exhaust to cool down if necessary. Disconnect the battery when working on the electrical system. Only use proper tools and always wear safety goggles and gloves during assembly and maintenance. Have a second person help you with assembly and maintenance.

ASSEMBLY: All parts and connections removed from the vehicle must be reinstalled according to the vehicle manufacturer's specifications or replaced with parts and hardware supplied by SW-MOTECH.

 **WARNING:** Secure all threads with a medium-strength liquid threadlocker, unless otherwise specified.

 **DANGER:** Tightening torques not defined by SW-MOTECH must be obtained from the vehicle manufacturer or a certified motorbike workshop.

FUNCTIONAL CHECK: After mounting the product, ensure that no moving parts are obstructed and that the function of the vehicle is not impeded. Cables and hoses must not rub against each other and/or be hindered in any way.

 **WARNING:** Carry out a comprehensive functionality check before you start to drive. Check the tightening torque of all connections and the tight fit of the product after the first 50 km and then at regular intervals. Mounted accessories can change the handling and stability of the vehicle.



SW-MOTECH GmbH & Co. KG
Ernteweg 7-10
35282 Rauschenberg
Germany



 info@sw-motech.com
 www.sw-motech.com



Take note of the symbols and what they mean in the ASSEMBLY section. If the term OEM appears in the ASSEMBLY section, the vehicle manufacturer's specifications must be observed and applied.



If you have any questions, please don't hesitate to contact our Customer Service team or our distributors. You can find our telephone number and a list of our distributors in our online shop:

www.sw-motech.com



Use thread locker: Indicates that a thread must be coated with liquid thread locker. H (HIGH): high strength; M (MEDIUM): medium strength; L (LOW): low strength.





































Tighten/note the tightening torque information:

Indicates the tightening torque of a part specified by SW-MOTECH or the vehicle manufacturer (OEM).



Do not use thread lock: Indicates that no liquid thread lock should be used at this point.

PARTS LIST - READ AND KEEP MOUNTING INSTRUCTIONS!

<p>3</p> <p>1</p>  <p>SBL.22.995.006.11</p> <p> 1/1</p>	<p>2</p>  <p>M8 x 20; DIN 6912 SC.ST.08.020.02.6912.088</p> <p> 2/2</p>	<p>3</p>  <p>∅ 8,4; DIN 125 US.ST.084.02.125</p> <p> 2/2</p>			
<p>6</p> <p>4</p>  <p>SBL.22.995.901.02.11</p> <p> 1/1</p>	<p>5</p>  <p>SBL.22.995.902.02.11</p> <p> 1/1</p>	<p>6</p>  <p>M12 x 365, DIN 6921 SC.ST.12.365.01.6921F.109</p> <p> 1/1</p>	<p>7</p>  <p>∅ 20 / ∅ 12.5 / h 5 DB.00.200.125.005.01</p> <p> 1/1</p>	<p>8</p>  <p>∅ 20 / ∅ 12.5 / h 44 DB.ST.0200.0125.0440.01</p> <p> 2/2</p>	<p>9</p>  <p>∅ 20 / ∅ 12.5 / h 10 DB.00.200.125.010.01</p> <p> 1/1</p>
<p>10</p>  <p>∅ 13; DIN 125 US.ST.130.01.125</p> <p> 1/1</p>	<p>11</p>  <p>M12; DIN 985 MU.ST.12.01.985F.10</p> <p> 1/1</p>	<p>12</p>  <p>M6 x 40; DIN 912 SC.ST.06.040.02.912.088</p> <p> 2/2</p>	<p>13</p>  <p>∅ 10 / ∅ 6.4 / 10 DB.ST.100.064.010.01</p> <p> 2/2</p>	<p>14</p>  <p>∅ 6.4; DIN 9021 US.ST.064.02.9021</p> <p> 4/4</p>	<p>15</p>  <p>M6; DIN 6927 MU.ST.06.02.6927.08</p> <p> 2/2</p>
<p>7</p> <p>16</p>  <p>SBL.22.995.004.11</p> <p> 1/1</p>	<p>17</p>  <p>M8 x 20; ISO 7380 SC.ST.08.020.02.7380.109</p> <p> 2/2</p>	<p>18</p>  <p>M8; DIN 6927 MU.ST.08.02.6927.08</p> <p> 2/2</p>	<p>19</p>  <p>SBL.00.051.005/B</p> <p> 2/2</p>		

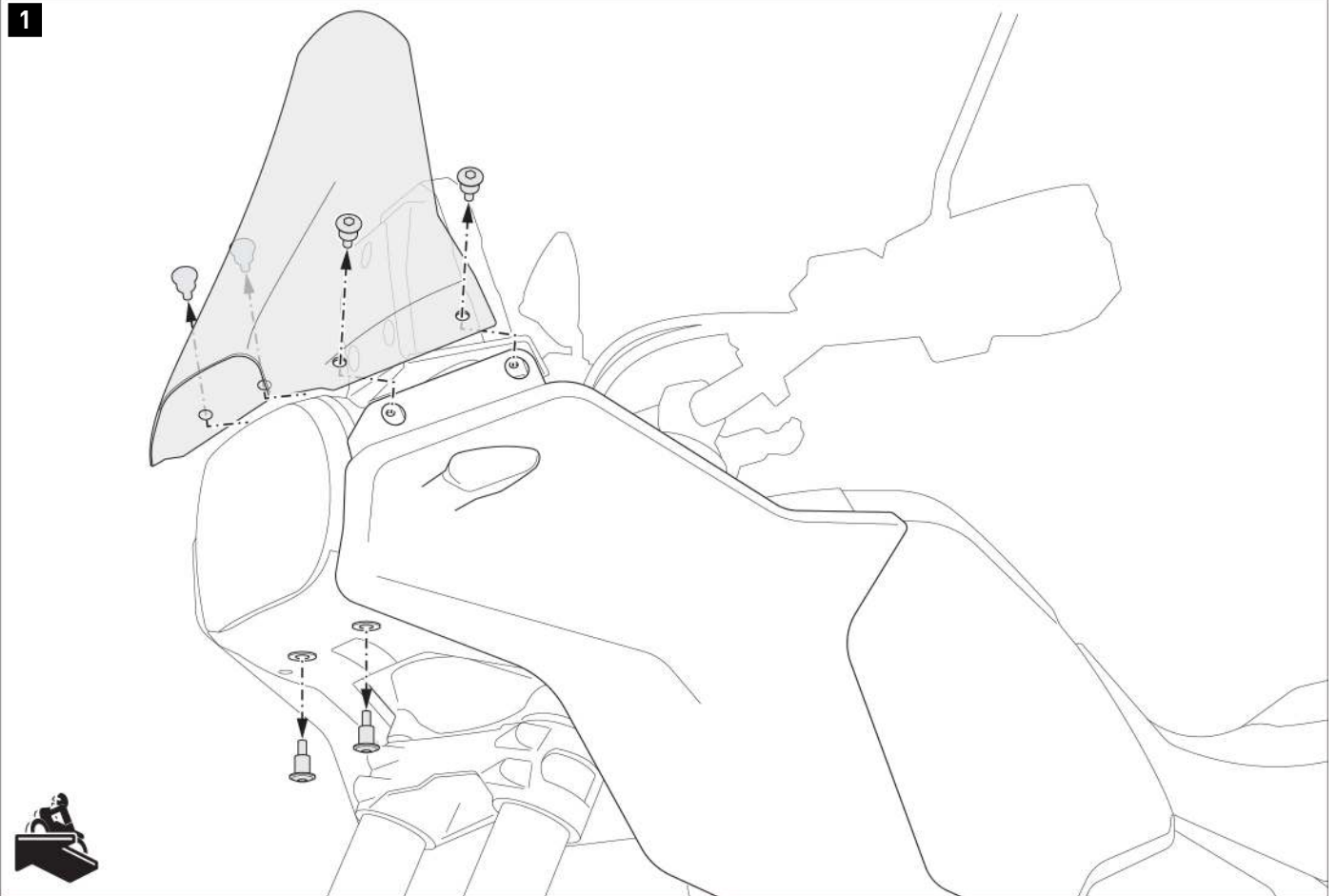

- ▲ **WARNING: Always wear eye and hand protection!**
- ▲ **WARNING: Always use suitable tools!**

Remove the screws shown, and disassemble the windscreen.



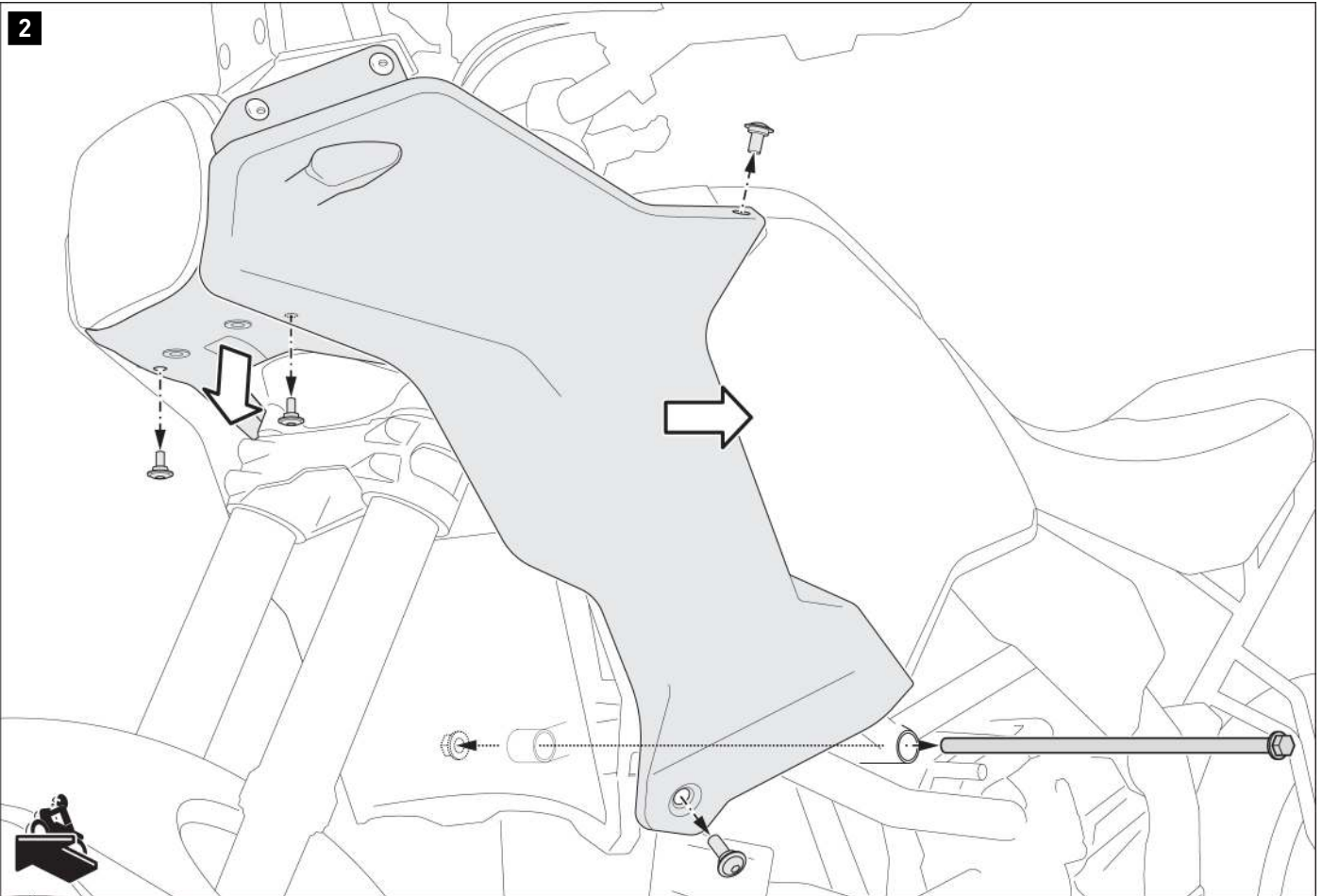

▲ WARNING: Ensure the engine is properly supported using a corresponding jack!

Loosen the screws shown, and disassemble the left side panel and the lower light cover.

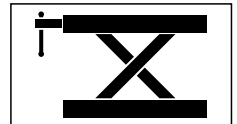

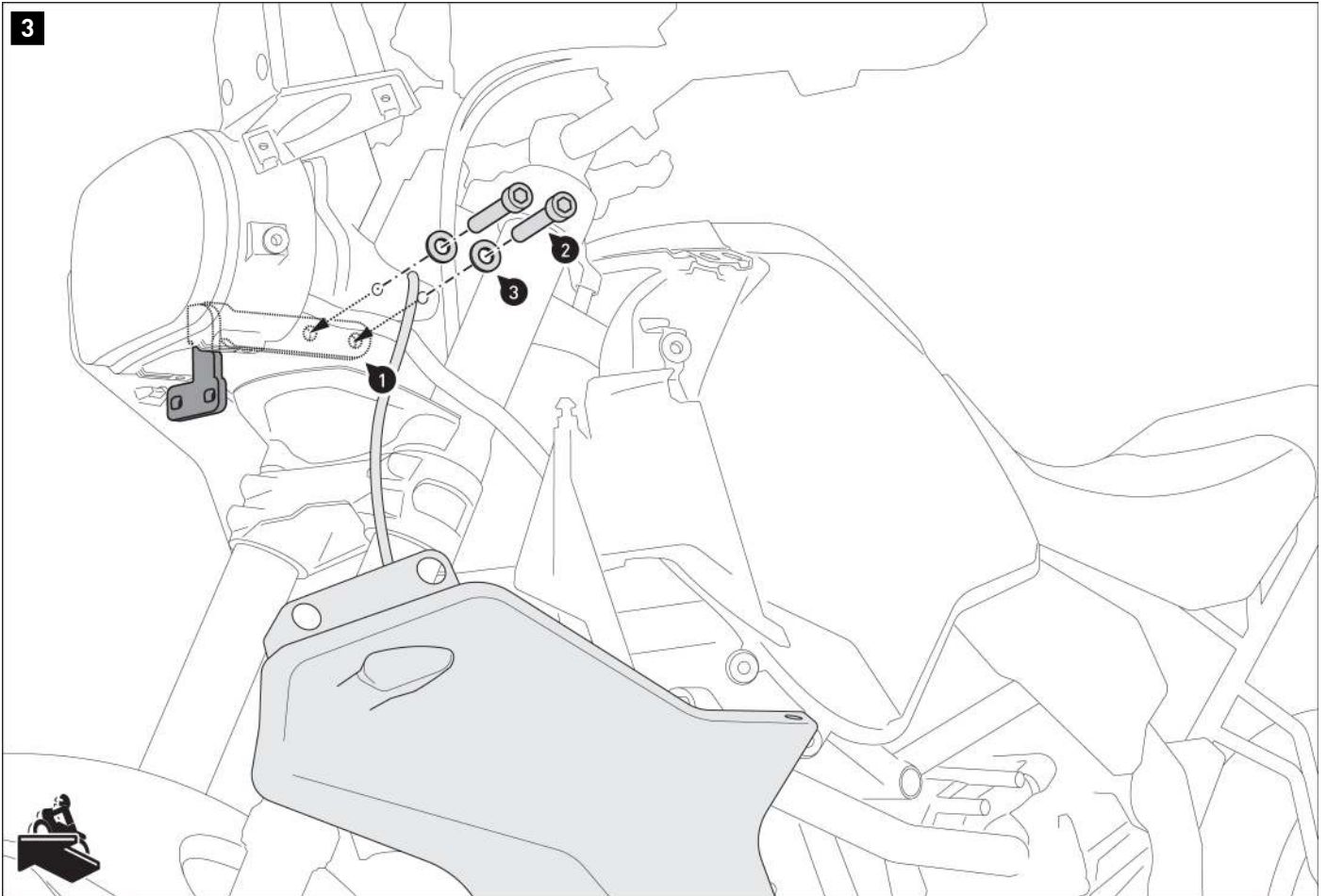

Screw the mounting bracket on the left side of the vehicle (1) to the inside of the steering head.

▲ WARNING: use liquid thread locker!

Tighten the screws according to the manufacturer's instructions.

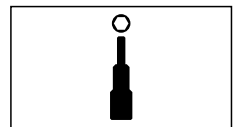
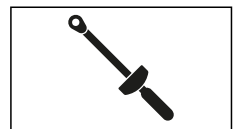

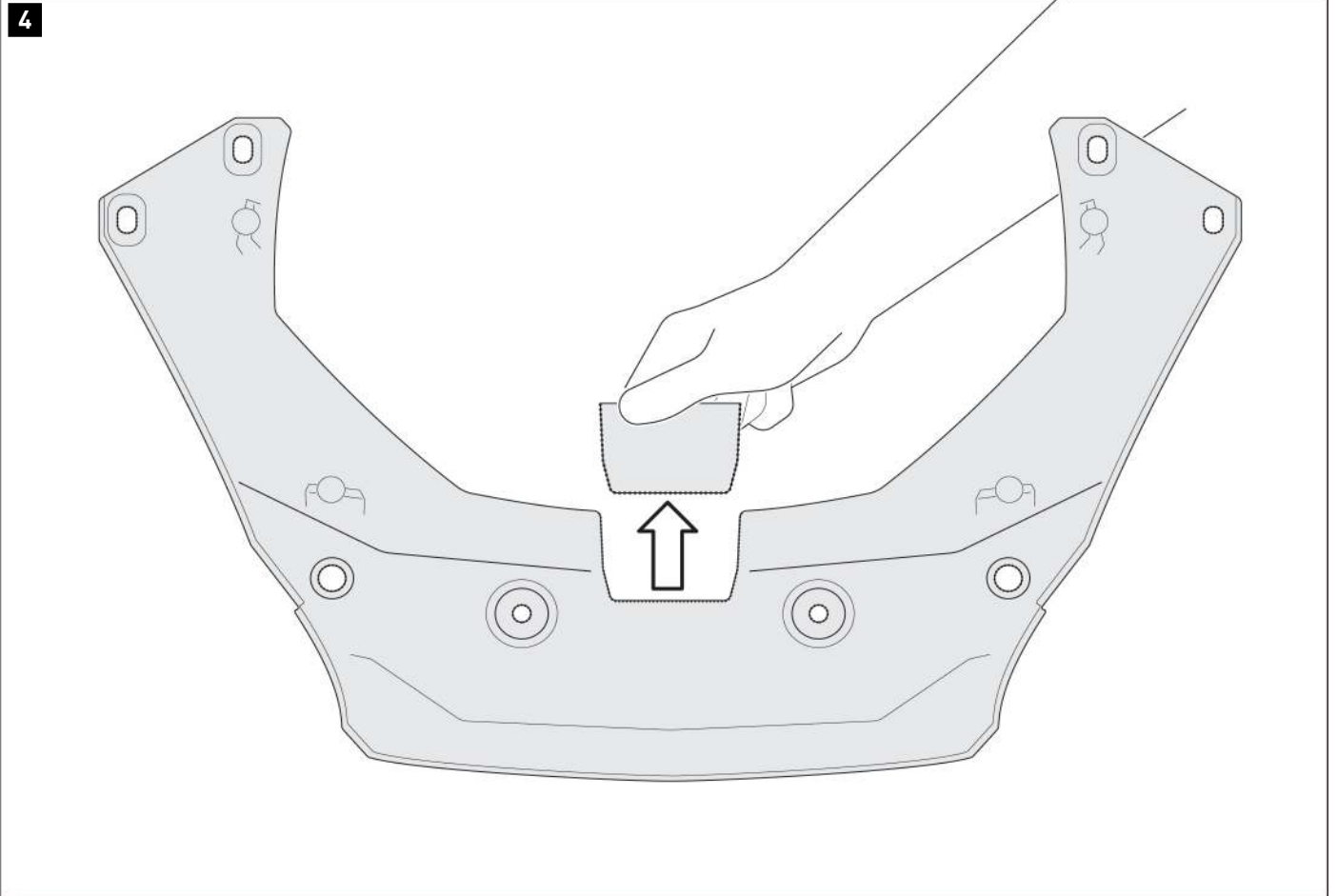

Carefully detach the pre-perforated part from the headlight cover.

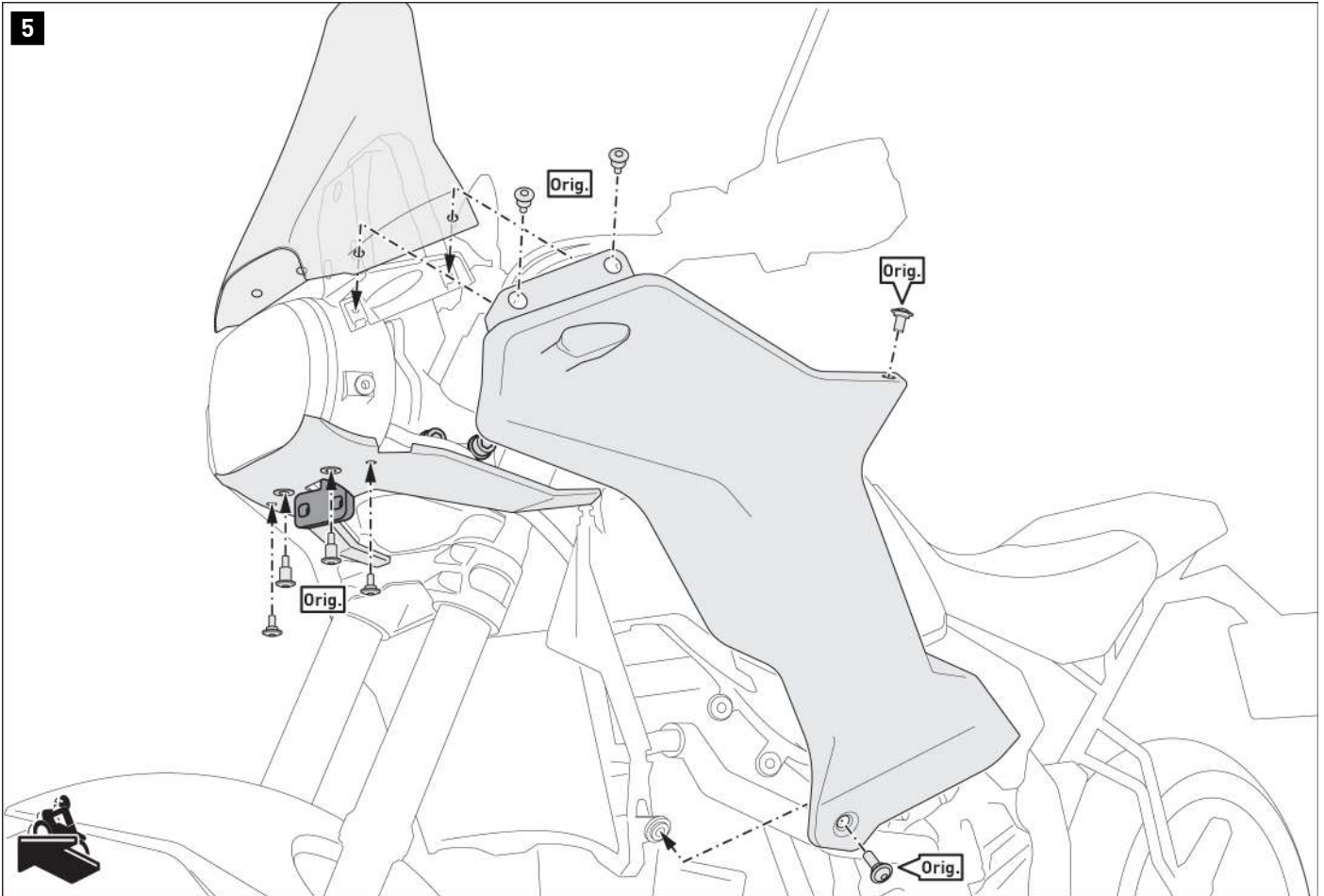

Reattach the previously disassembled trim parts to the vehicle.

▲ WARNING: use liquid thread locker!

Tighten the original (Orig.) screws according to the manufacturer's instructions.

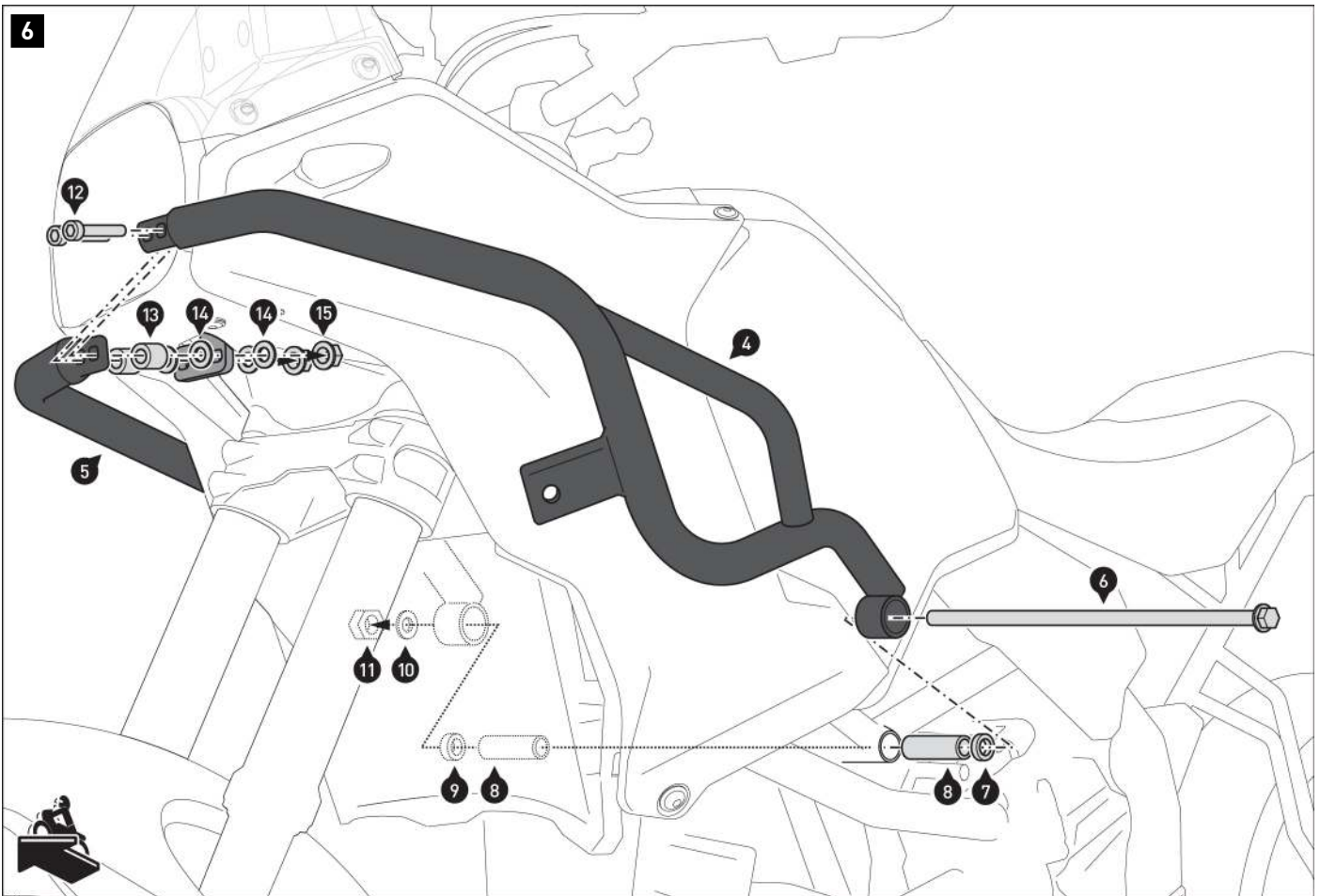

⚠NOTE: If the crash bars are fitted at the same time as the SW-MOTECH engine guard, spacers (7) and (9) are not required.

Screw the crash bar halves (4) and (5) to the vehicle and to the mounting bracket (1).
Do not tighten the screws yet.

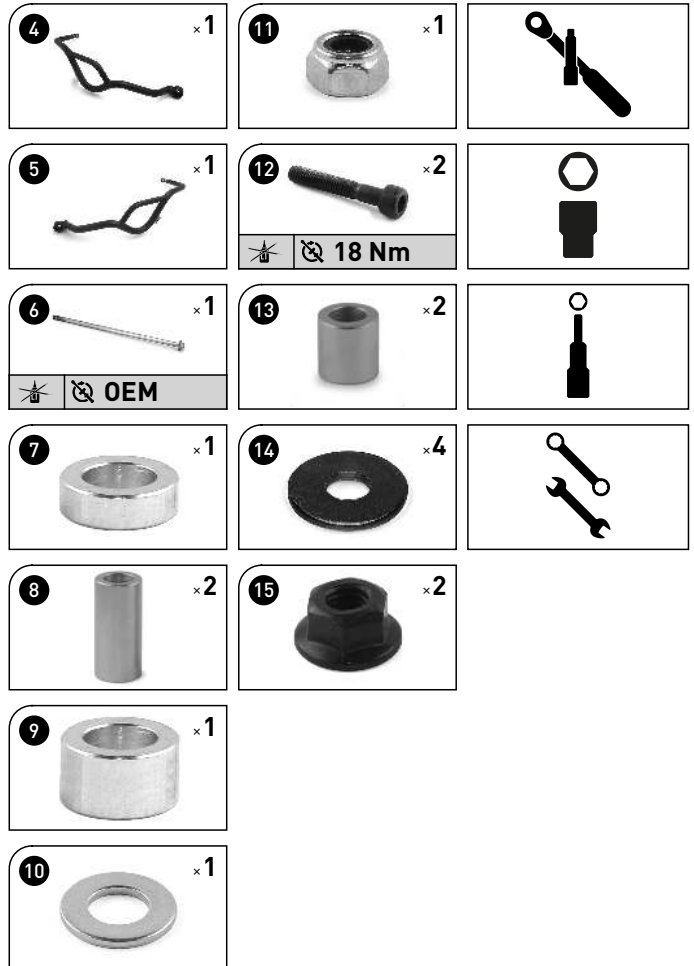

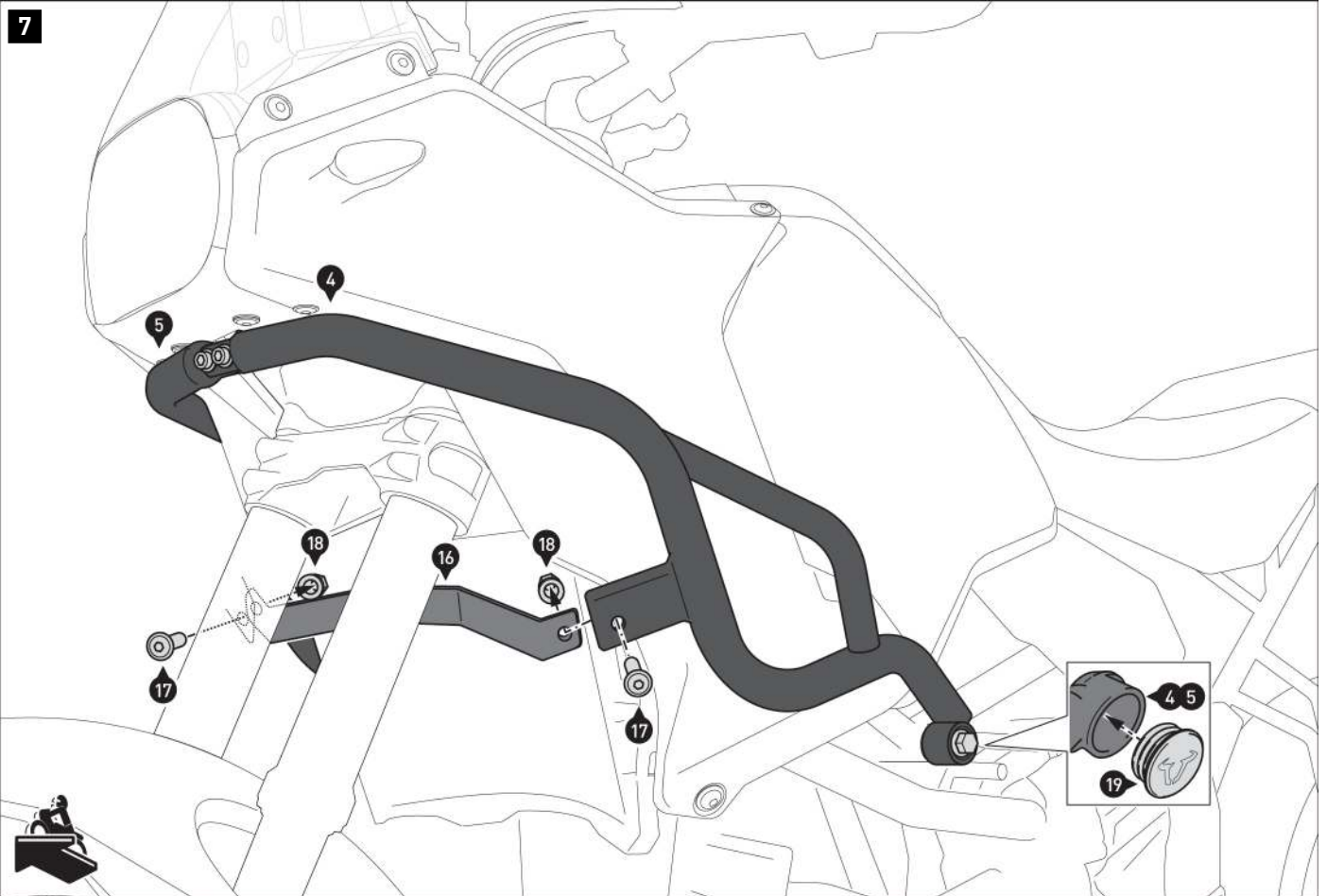

Now screw the crossbar (16) to the crash bar halves (4) and (5).

When all components are loosely attached, tighten all screws as specified in the mounting instructions.

Insert the end caps (19) into the crash bar openings on both sides of the vehicle.

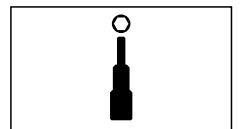
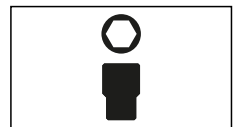
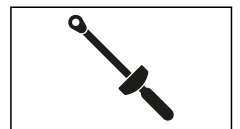

PRODUCT-SPECIFIC NOTES

⚠ WARNING: This product may inhibit cornering and ground clearance in cases of extreme inclination!

⚠ NOTE: Please observe the country-specific regulations for the registration/operation of your vehicle or any applicable TÜV regulations. After installation, parts subject to registration should be entered in the vehicle documents by your test center.

Item number: **MSS.22.995.10000/B**

Revision: **00** · Date: **01 - 2023**

Engine guard

 ~ 1.5 h.

EASY  DIFFICULT

ENGLISH · Thank you for choosing this premium product from SW-MOTECH. Visit our online shop for more information (e.g. model assignments). Required documents (e.g. national type approval) are available there for you to download.

Please read and understand all the instructions, safety information and warnings in these mounting instructions before mounting and using the product in order to avoid injury and damage. Keep these mounting instructions for reference.

This product was developed for vehicles in factory condition. Compatibility with original accessories or accessories from other manufacturers cannot be guaranteed.

These mounting instructions have been prepared to the best of our current knowledge. No legal claims relating to accuracy can be made. Errors and omissions excepted. We reserve the right to make technical and design changes. The copyright is held by SW-MOTECH.

SAFETY WARNING SYMBOL

 This warning symbol is used in these mounting instructions to warn of deadly dangers, injuries or other hazards. The words **DANGER**, **WARNING** or **CAUTION** are used as part of this warning symbol to convey important safety messages and information relating to the installation and use of this product. These words, together with the safety warning symbol, mean:

 **DANGER:** Indicates a hazardous situation which, if not avoided, will result in death or serious injury!

 **WARNING:** Indicates a hazardous situation which, if not avoided, may result in death or serious injury!

 **CAUTION:** Indicates a hazardous situation which, if not avoided, may result in minor or moderate injury!

 **NOTE:** Important information, but not relating to a risk of death or injury (property damage only)!

GENERAL INFORMATION

 **WARNING:** Assembly and/or maintenance of this product requires advanced technical skill, appropriate tools, and a good understanding of tool usage and torque specifications. For your own safety, SW-MOTECH recommends having the assembly and/or maintenance carried out by a qualified and certified motorcycle workshop.

 **WARNING:** If you do choose to assemble this product yourself, carefully and fully read the mounting instructions before assembly and use, and follow all instructions to avoid serious injury or death. Also observe all relevant information in the vehicle manual when mounting or using the product. **IF YOU DO NOT UNDERSTAND ANY PART OF THESE MOUNTING INSTRUCTIONS OR NEED AN EXPLANATION AS TO A SPECIFIC INSTRUCTION, DO NOT ATTEMPT TO INSTALL THIS PRODUCT WITHOUT CONSULTING SW-MOTECH FOR ASSISTANCE!**

PREPARATION: Read the mounting instructions carefully and make sure that all parts on the parts list are available.

 **CAUTION:** Ensure that your vehicle is standing securely. Switch off the engine and remove the ignition key. Allow the engine/exhaust to cool down if necessary. Disconnect the battery when working on the electrical system. Only use proper tools and always wear safety goggles and gloves during assembly and maintenance. Have a second person help you with assembly and maintenance.

ASSEMBLY: All parts and connections removed from the vehicle must be reinstalled according to the vehicle manufacturer's specifications or replaced with parts and hardware supplied by SW-MOTECH.

 **WARNING:** Secure all threads with a medium-strength liquid threadlocker, unless otherwise specified.

 **DANGER:** Tightening torques not defined by SW-MOTECH must be obtained from the vehicle manufacturer or a certified motorbike workshop.



FUNCTIONAL CHECK: After mounting the product, ensure that no moving parts are obstructed and that the function of the vehicle is not impeded. Cables and hoses must not rub against each other and/or be hindered in any way.

 **WARNING:** Carry out a comprehensive functionality check before you start to drive. Check the tightening torque of all connections and the tight fit of the product after the first 50 km and then at regular intervals. Mounted accessories can change the handling and stability of the vehicle.



SW-MOTECH GmbH & Co. KG
Ernteweg 7-10
35282 Rauschenberg
Germany



 info@sw-motech.com
 www.sw-motech.com

LEGEND OVERVIEW - READ AND KEEP MOUNTING INSTRUCTIONS!



Take note of the symbols and what they mean in the ASSEMBLY section. If the term OEM appears in the ASSEMBLY section, the vehicle manufacturer's specifications must be observed and applied.



If you have any questions, please don't hesitate to contact our Customer Service team or our distributors. You can find our telephone number and a list of our distributors in our online shop:
www.sw-motech.com



Tighten/note the tightening torque information:
Indicates the tightening torque of a part specified by SW-MOTECH or the vehicle manufacturer (OEM).



Do not use thread lock: Indicates that no liquid thread lock should be used at this point.



Use thread locker: Indicates that a thread must be coated with liquid thread locker. H (HIGH): high strength; M (MEDIUM): medium strength; L (LOW): low strength.

PARTS LIST - READ AND KEEP MOUNTING INSTRUCTIONS!

<p>4</p> <p>1</p>  <p>MSS.22.995.900.01.02</p> <p> 1/1</p>	<p>2</p>  <p>GT.0120.0100.0088.0040</p> <p> 5/5</p>	<p>3</p>  <p>Ø 10 / ø 8.4 / h 8.8 DB.ST.100.084.088.01</p> <p> 5/5</p>			
<p>5</p> <p>4</p>  <p>MSS.22.995.005.11</p> <p> 1/1</p>	<p>5</p>  <p>MSS.22.995.003.11</p> <p> 1/1</p>	<p>6</p>  <p>M12 x 335; DIN 6921 SC.ST.12.335.01.6921F.109</p> <p> 1/1</p>	<p>7</p>  <p>Ø 20 / ø 12.5 / h 45 DB.ST.200.125.045.01</p> <p> 2/2</p>	<p>8</p>  <p>Ø 20 / ø 12.5 / h 5 DB.00.200.125.005.01</p> <p> 1/1</p>	
<p>6</p> <p>9</p>  <p>MSS.22.995.004.11</p> <p> 1/1</p>	<p>10</p>  <p>M12 x 40; DIN 912 SC.ST.12.040.01.912.088</p> <p> 1/1</p>	<p>11</p>  <p>M12 x 50; DIN 912 SC.ST.12.050.01.912.088</p> <p> 1/1</p>	<p>12</p>  <p>ø 13; DIN 125 US.ST.130.01.125</p> <p> 1/1</p>	<p>13</p>  <p>Ø 25 / ø 12.5 / h 5.5 DB.ST.250.125.0055.01</p> <p> 1/1</p>	<p>14</p>  <p>M12; DIN 6927 MU.ST.12.02.6927.08</p> <p> 1/1</p>
<p>15</p>  <p>M5 x 14; DIN 912 SC.ST.05.014.02.912.088</p> <p> 2/2</p>	<p>16</p>  <p>ø 5.3; DIN 9021 US.ST.053.02.9021</p> <p> 2/2</p>	<p>17</p>  <p>MSS.22.995.002.11</p> <p> 1/1</p>	<p>18</p>  <p>M6 x 16; DIN 933 SC.ST.06.016.01.933.088</p> <p> 2/2</p>	<p>19</p>  <p>ø 6.4; DIN 125 US.ST.064.02.125</p> <p> 2/2</p>	
<p>7</p> <p>20</p>  <p>M8 x 30; DIN 931 SC.ST.08.030.01.931.088</p> <p> 3/3</p>	<p>21</p>  <p>ø 8,4; DIN 125 US.ST.084.02.125</p> <p> 4/4</p>	<p>22</p>  <p>M8 x 25; ISO 7380 SC.ST.08.025.02.7380.109</p> <p> 1/1</p>	<p>23</p>  <p>M8 x 30; ISO 7380 SC.ST.08.030.02.7380.109</p> <p> 1/1</p>	<p>24</p>  <p>ø 8,4; DIN 9021 US.ST.084.02.9021</p> <p> 4/4</p>	<p>25</p>  <p>M8; DIN 6927 MU.ST.08.02.6927.08</p> <p> 4/4</p>

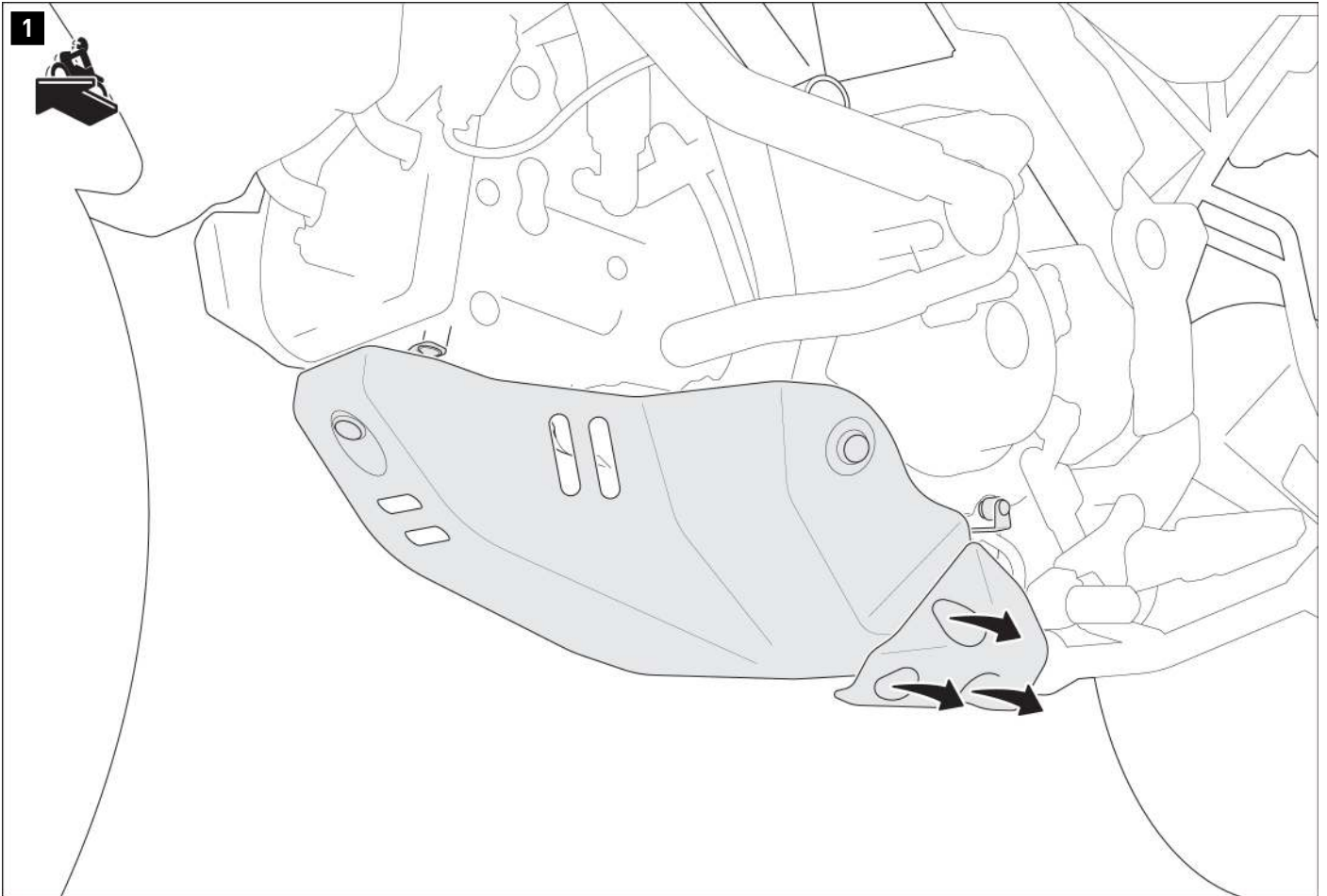

- ▲ WARNING: Always wear eye and hand protection!**
- ▲ WARNING: Always use the proper tools!**

Loosen the indicated screws on the plastic cover.
Remove the plastic cover from the vehicle.



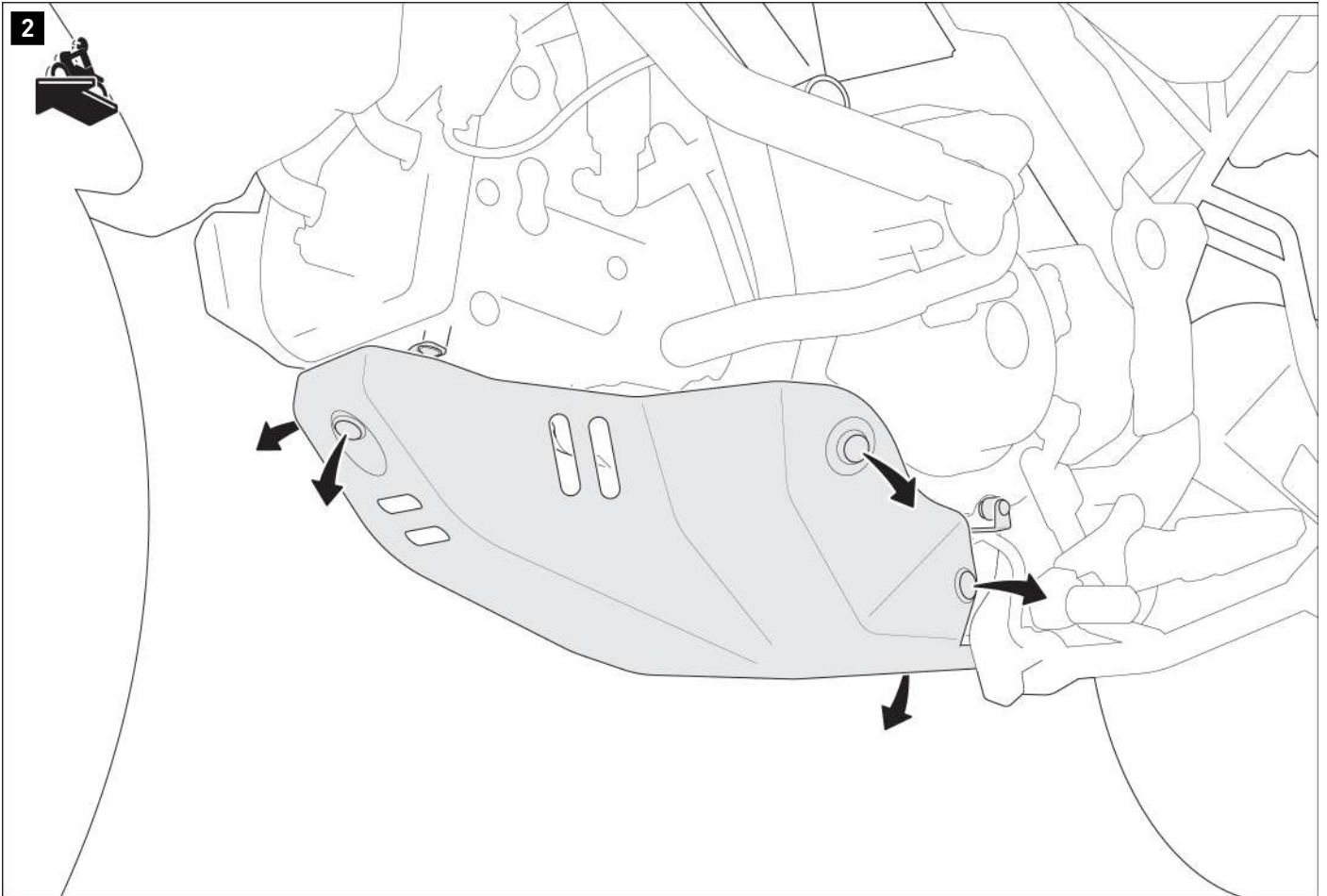

Loosen the indicated screws on the original engine guard.
Remove the engine guard from the vehicle.

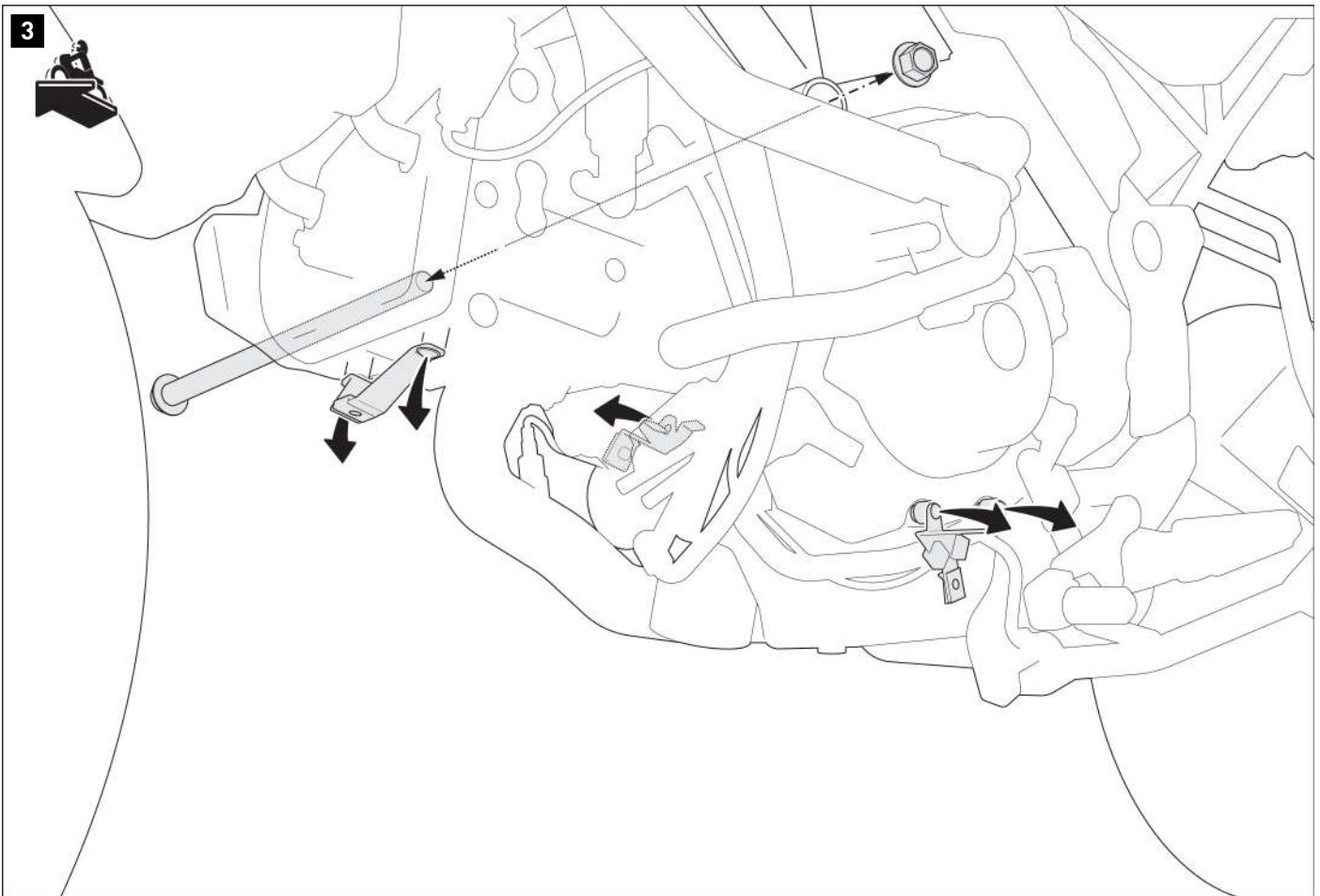

▲ WARNING: Ensure the engine is properly supported using a corresponding jack!

Loosen the engine bolt nut as indicated.
Remove the engine bolt from the vehicle.

Loosen the indicated screws on the retaining plates on both sides.
Loosen the cable tie on the left retaining plate.
Remove the retaining plates from the vehicle.

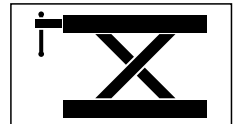

4

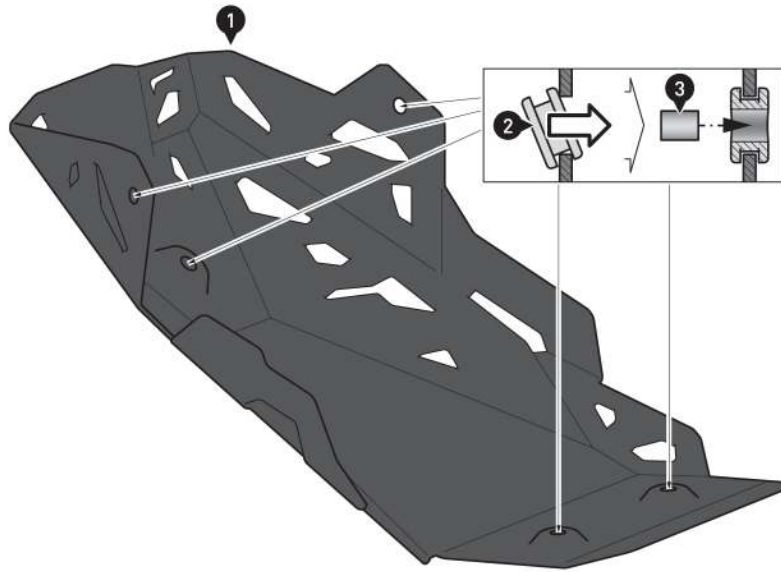

Insert the rubber grommets (2) into the openings of the engine guard (1).
Then press the spacers (3) into the openings of the rubber grommets (2).



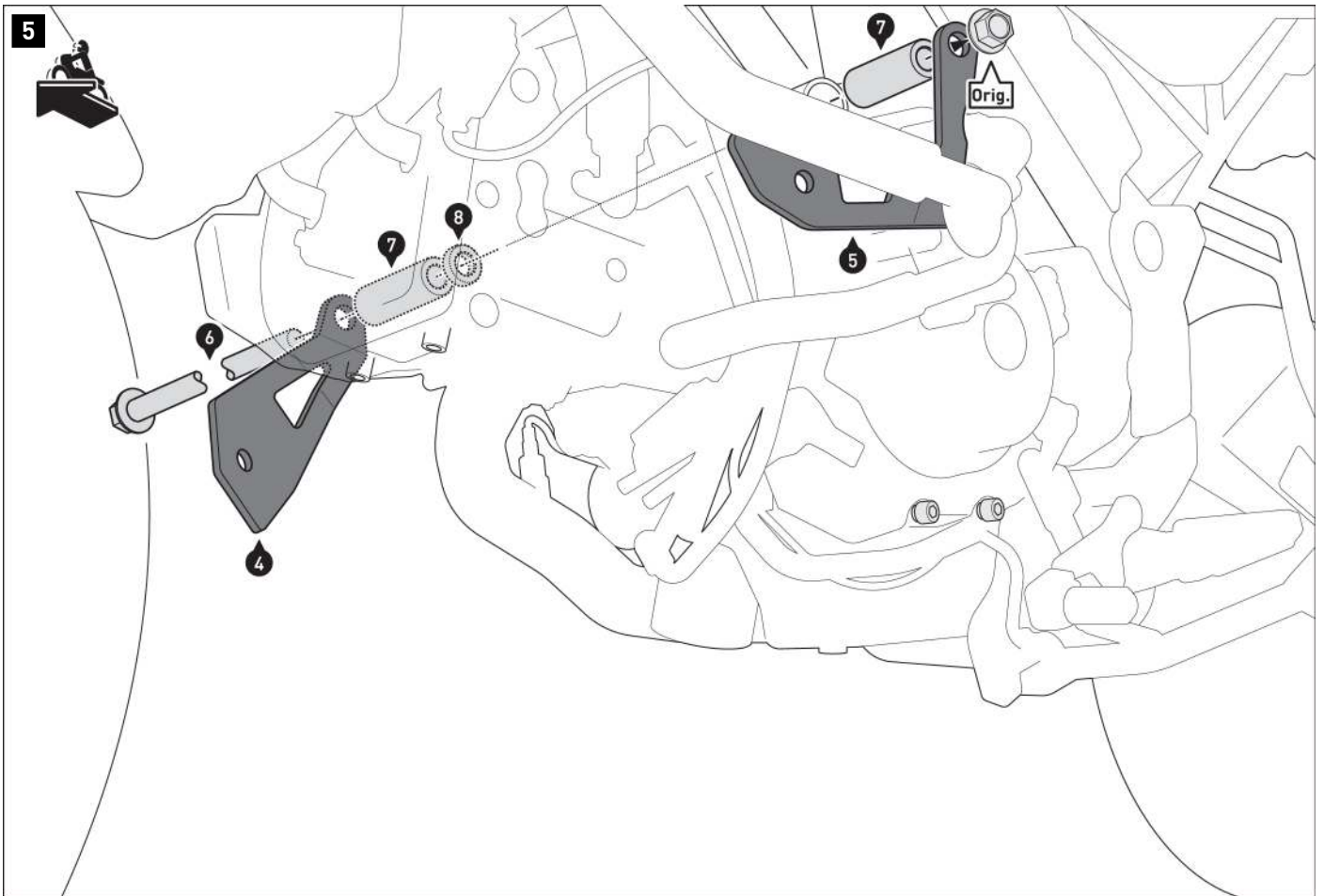

⚠NOTE: Use the indicated parts when mounting the SW-MOTECH crash bar at the same time. The crash bars are screwed onto the mounting brackets (4) and (5).

Screw the mounting brackets (4) and (5) to the vehicle on both sides using the original nut (Orig.). Do not tighten the screw yet.

Then remove the jack.

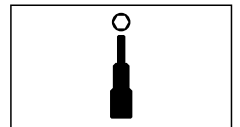

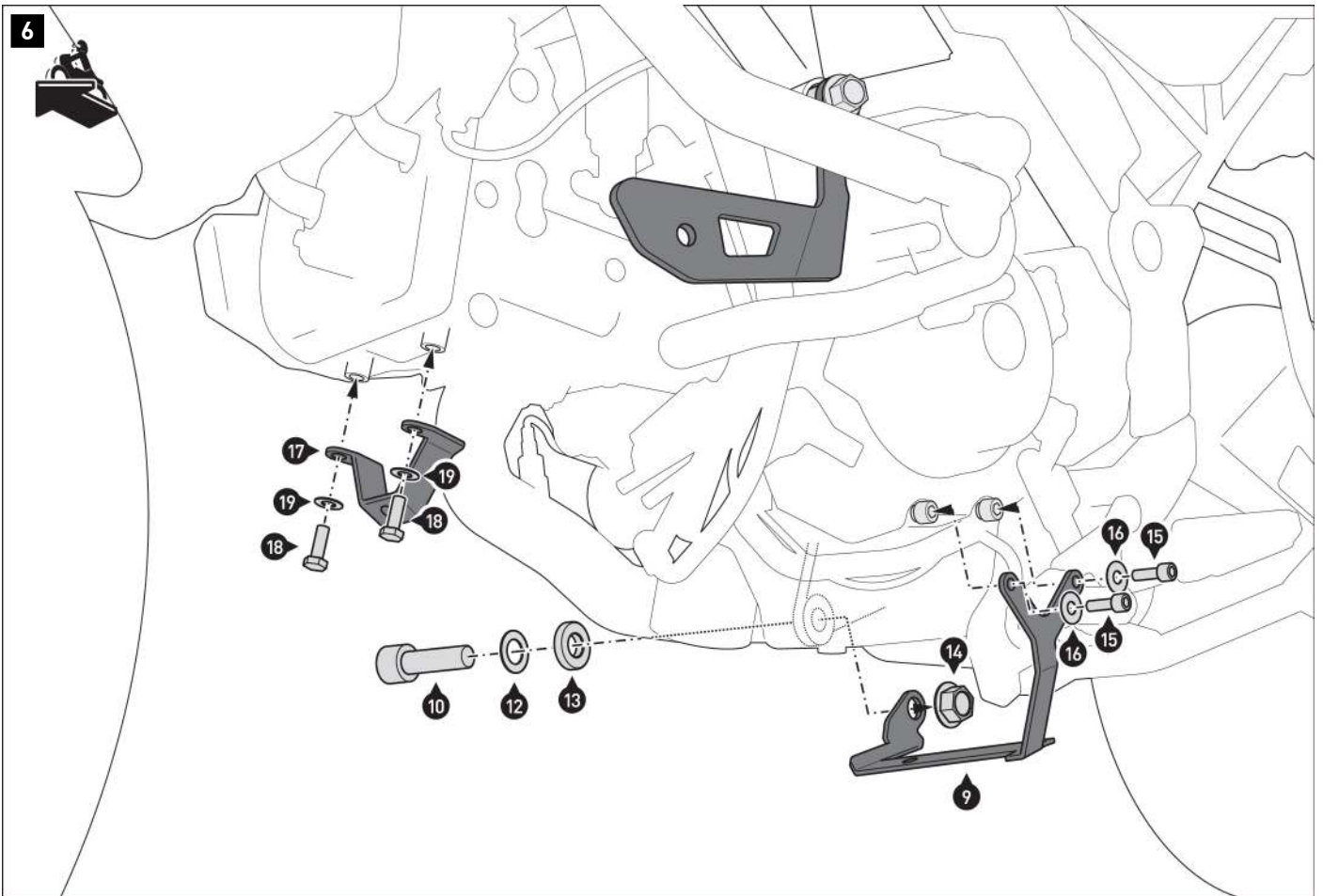











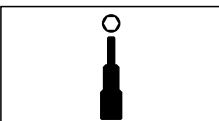

NOTE: Use the screw (11) at the left attachment point when mounting the SW-MOTECH centerstand at the same time. Parts (12) and (13) are omitted. Use the parts on the centerstand instead.

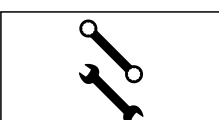
Screw the mounting brackets (9) and (17) to the vehicle.

WARNING: Use liquid thread locker (NOT on screws (10) and (11))! Do not tighten the screws yet.

 ×1	 ×2	
 ×1 ⚠ 60 Nm	 ×1	
 ×1 ⚠ 60 Nm	 ×2 M 8 Nm	
 ×1	 ×2	
 ×1		
 ×1		
 ×2 M OEM		

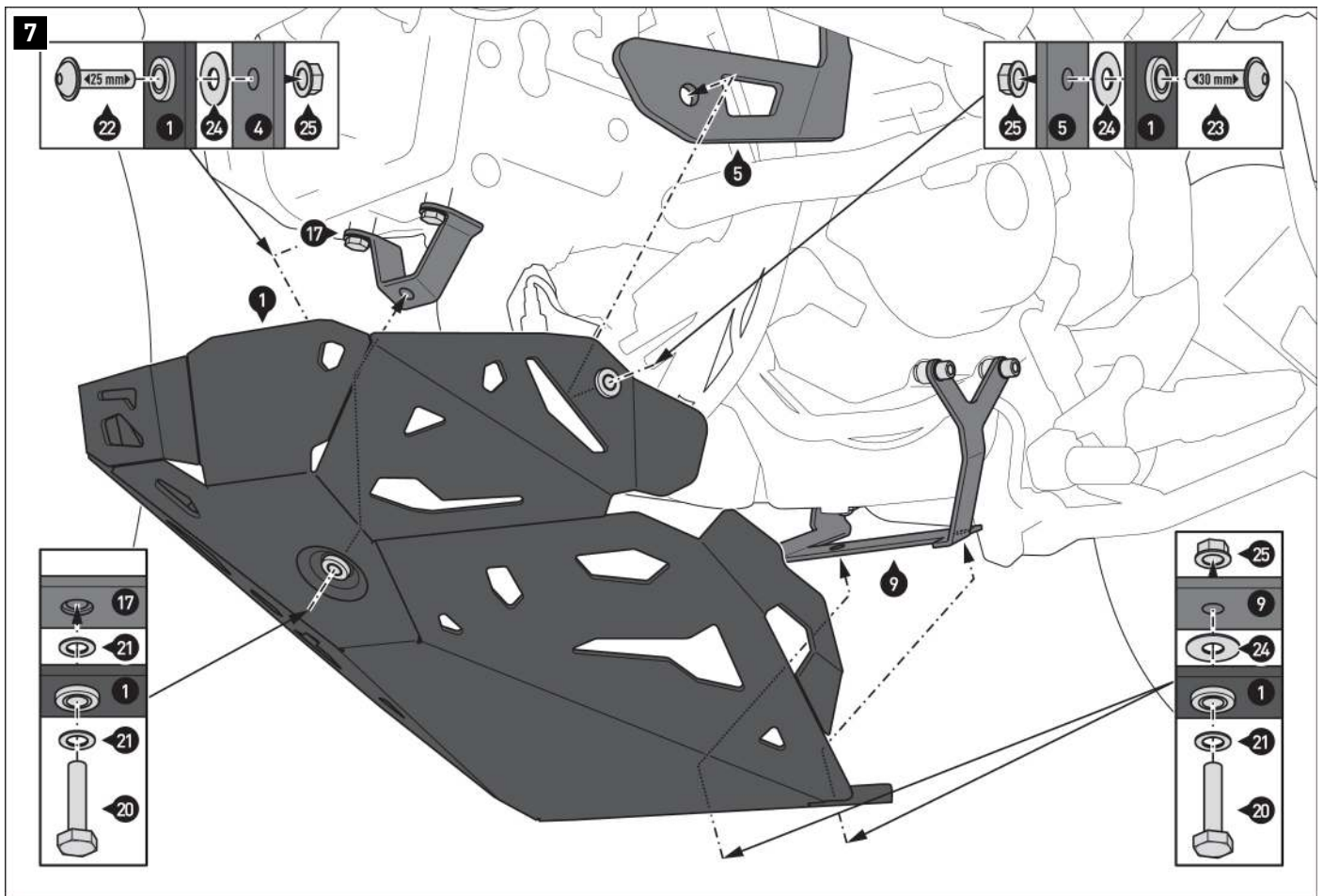

Screw the engine guard (1) to the mounting brackets (4), (5), (9) and (17).

▲WARNING: Use liquid thread locker (front screw (20) only)!

When all components are loosely attached, tighten all screws as specified in the mounting instructions. Concealed screws can be tightened through the recesses in the engine guard.

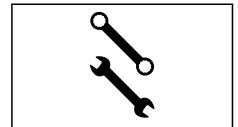
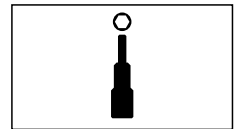
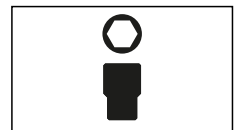
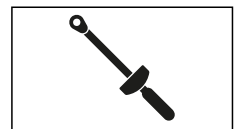

PRODUCT-SPECIFIC NOTES

⚠ WARNING: Ground clearance may be restricted by this product! Particular caution is required when cornering at extreme inclination and/or driving on uneven ground (e.g. curbs and bumps)!

⚠ WARNING: Motorcycle exhaust pipes often have large geometric tolerances. Make sure that there is sufficient distance between all parts in the affected areas!

⚠ NOTE: *Please observe the country-specific regulations for the registration/operation of your vehicle or any applicable TÜV regulations. After installation, parts subject to registration should be entered in the vehicle documents by your test center.*

Item number: HDG.00.220.80602/B

Revision: 00 · Date: 05 - 2024

Handguard mounting kit

 ~ 0.5 h.

 EASY     DIFFICULT

ENGLISH Thank you for choosing this premium product from SW-MOTECH. Visit our online shop for more information (e.g. model assignments). Required documents (e.g. national type approval) are available there for you to download.

Please read and understand all the instructions, safety information and warnings in these mounting instructions before mounting and using the product in order to avoid injury and damage. Keep these mounting instructions for reference.

This product was developed for vehicles in factory condition. Compatibility with original accessories or accessories from other manufacturers cannot be guaranteed.

These mounting instructions have been prepared to the best of our current knowledge. No legal claims relating to accuracy can be made. Errors and omissions excepted. We reserve the right to make technical and design changes. The copyright is held by SW-MOTECH.

SAFETY WARNING SYMBOL

 This warning symbol is used in these mounting instructions to warn of deadly dangers, injuries or other hazards. The words **DANGER**, **WARNING** or **CAUTION** are used as part of this warning symbol to convey important safety messages and information relating to the installation and use of this product. These words, together with the safety warning symbol, mean:

 **DANGER:** Indicates a hazardous situation which, if not avoided, will result in death or serious injury!

 **WARNING:** Indicates a hazardous situation which, if not avoided, may result in death or serious injury!

 **CAUTION:** Indicates a hazardous situation which, if not avoided, may result in minor or moderate injury!

 **NOTE:** Important information, but not relating to a risk of death or injury (property damage only)!

GENERAL INFORMATION

 **WARNING:** Assembly and/or maintenance of this product requires advanced technical skill, appropriate tools, and a good understanding of tool usage and torque specifications. For your own safety, SW-MOTECH recommends having the assembly and/or maintenance carried out by a qualified and certified motorcycle workshop.

 **WARNING:** If you do choose to assemble this product yourself, carefully and fully read the mounting instructions before assembly and use, and follow all instructions to avoid serious injury or death. Also observe all relevant information in the vehicle manual when mounting or using the product. IF YOU DO NOT UNDERSTAND ANY PART OF THESE MOUNTING INSTRUCTIONS OR NEED AN EXPLANATION AS TO A SPECIFIC INSTRUCTION, DO NOT ATTEMPT TO INSTALL THIS PRODUCT WITHOUT CONSULTING SW-MOTECH FOR ASSISTANCE!

PREPARATION: Read the mounting instructions carefully and make sure that all parts on the parts list are available.

 **CAUTION:** Ensure that your vehicle is standing securely. Switch off the engine and remove the ignition key. Allow the engine/exhaust to cool down if necessary. Disconnect the battery when working on the electrical system. Only use proper tools and always wear safety goggles and gloves during assembly and maintenance. Have a second person help you with assembly and maintenance.

ASSEMBLY: All parts and connections removed from the vehicle must be reinstalled according to the vehicle manufacturer's specifications or replaced with parts and hardware supplied by SW-MOTECH.

 **WARNING:** Secure all threads with a medium-strength liquid threadlocker, unless otherwise specified.

 **DANGER:** Tightening torques not defined by SW-MOTECH must be obtained from the vehicle manufacturer or a certified motorbike workshop.



FUNCTIONAL CHECK: After mounting the product, ensure that no moving parts are obstructed and that the function of the vehicle is not impeded. Cables and hoses must not rub against each other and/or be hindered in any way.

 **WARNING:** Carry out a comprehensive functionality check before you start to drive. Check the tightening torque of all connections and the tight fit of the product after the first 50 km and then at regular intervals. Mounted accessories can change the handling and stability of the vehicle.



SW-MOTECH GmbH & Co. KG
Ernteweg 7-10
35282 Rauschenberg
Germany



 info@sw-motech.com
 www.sw-motech.com

LEGEND OVERVIEW - READ AND KEEP MOUNTING INSTRUCTIONS!



Take note of the symbols and what they mean in the ASSEMBLY section. If the term OEM appears in the ASSEMBLY section, the vehicle manufacturer's specifications must be observed and applied.



If you have any questions, please don't hesitate to contact our Customer Service team or our distributors. You can find our telephone number and a list of our distributors in our online shop:

www.sw-motech.com



Use thread locker: Indicates that a thread must be coated with liquid thread locker. H (HIGH): high strength; M (MEDIUM): medium strength; L (LOW): low strength.



Tighten/note the tightening torque information:

Indicates the tightening torque of a part specified by SW-MOTECH or the vehicle manufacturer (OEM).



Do not use thread lock: Indicates that no liquid thread lock should be used at this point.

PARTS LIST - READ AND KEEP MOUNTING INSTRUCTIONS!

1

1



HDG.00.220.904.01.02

 1/1

2



HDG.00.220.905.01.02

 1/1

3



HDG.00.220.034L.25

 1/1

4



HDG.00.220.034R.25

 1/1

5



M6 x 20; DIN 7380
SC.ST.06.020.02.7380.109

 2/2

2

6



HDG.00.220.029L.25

 1/1

7



HDG.00.220.029R.25

 1/1

8



M8 x 65; DIN 6912
SC.ST.08.065.02.6912.088

 2/2

9



HDG.00.220.011.25

 2/2

10



HDG.00.220.073.35

 2/2

11



Ø 20 / ø 8,2 / h 13
DB.ST.0200.0082.0130.02

 2/2

12



HDG.00.220.053.01

 2/2

13



HDG.00.220.019.01

 2/2

3

14



M6 x 22; DIN 7991
SC.ST.06.022.48.7991.088

 2/2

15



ø 6.4; DIN 9021
US.ST.064.02.9021

 2/2

16



M6; DIN 6927
MU.ST.06.02.6927.08

 2/2

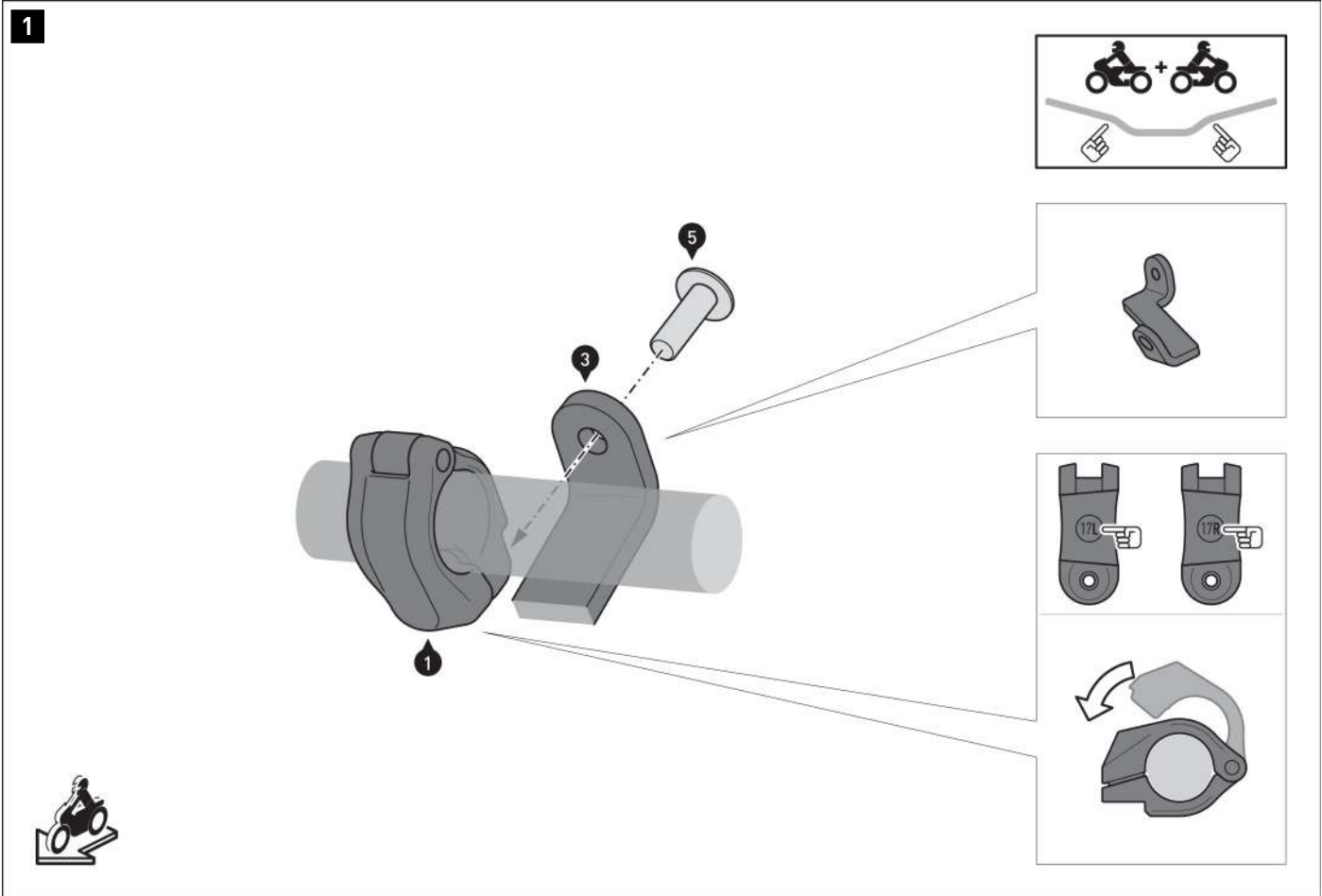

⚠ WARNING: Since the handguard mounting kit is installed in a safety-relevant area of the vehicle, SW-MOTECH recommends having the installation/maintenance of the product carried out by a qualified specialist workshop.

⚠ WARNING: Always wear eye and hand protection!
⚠ WARNING: Always use the proper tools!

⚠ NOTE: Installation is shown on the left side. Repeat the installation with the corresponding parts on the right side of the handlebar.

⚠ NOTE: The handlebar shown serves as an example.

⚠ NOTE: The connecting plate (3) shown in the drawing serves as an example. The correct representation and orientation of the connecting plate are shown in the detailed drawing on the right.

⚠ NOTE: Pay attention to the L/R markings on the clamps (1/2). Attach the clamp with the L marking on the left side of the handlebar in the direction of travel; attach the clamp with the R engraving to the right side of the handlebar in the direction of travel.

Place the clamps (1/2) around the handlebars at the locations shown in the detailed drawing above.

LOOSELY screw the connecting plates (3/4) to the clamps (1/2). The clamps (1/2) must be able to be moved for positioning.

⚠ WARNING: Use a liquid threadlocker!
 Tighten the screws (5) hand-tight.

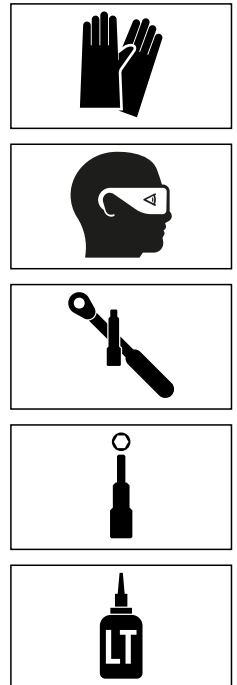

2

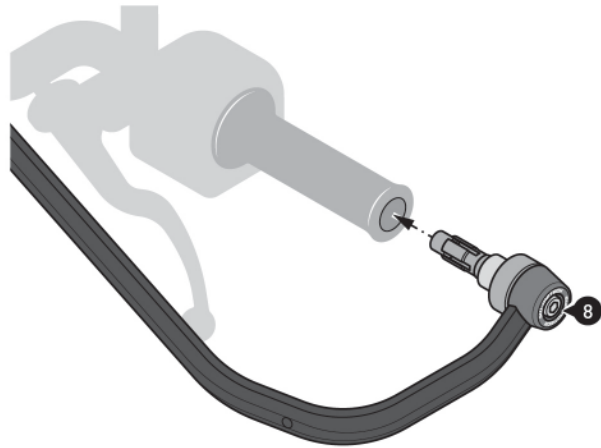
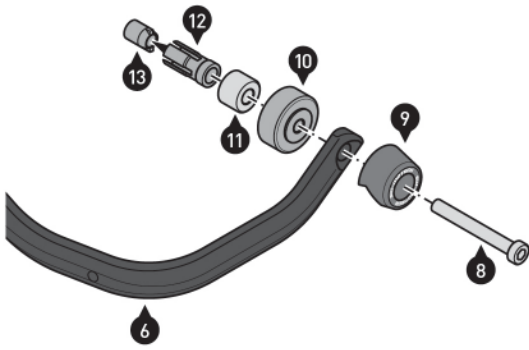
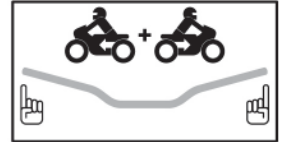

Remove the original end weights and handguards if mounted.
Make sure the handlebar ends and the inside of the handlebars are clear.

Loosely screw the parts indicated to the brackets (6/7) as shown in the drawing above.

▲ WARNING: Use a liquid threadlocker!
The screws (8) should only be loosely attached.

Install the brackets (6/7) on to the handlebar ends as shown in the drawing below.
To do so, tighten the screws (8) so that the expansion sleeves (12) are firmly positioned on the inside, but the brackets (6/7) can still be readjusted.

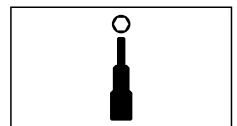

M 18 Nm



3

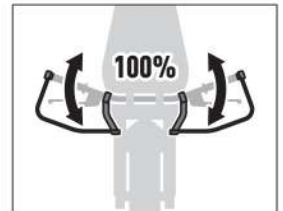
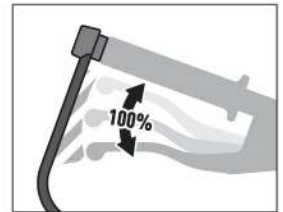
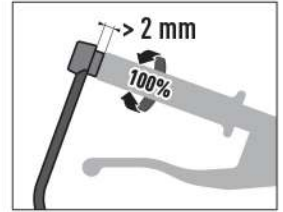
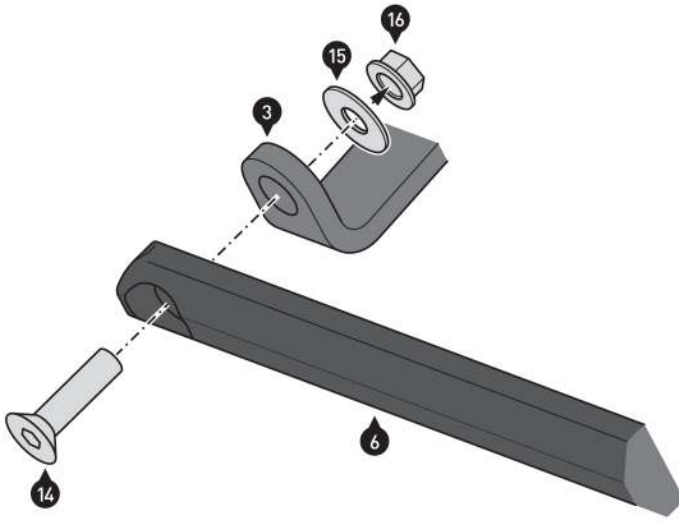

Screw the inner ends of the brackets (5/6) to the connecting plates (2/3). Do not tighten the screws (13) yet.

Now position the brackets (5/6) according to your driving ergonomics and tighten all the screws in the following order and as specified in the mounting instructions: (13), (4), (7).

▲ DANGER: If there is not enough space after installation of all components, the brake and clutch unit must be moved a few millimeters towards the end or middle of the handlebar!

▲ DANGER: After installation, make sure that all switch and control units, especially the throttle assembly, brake lever, emergency stop switch and clutch, function properly and are easy to use! Also make sure that the handlebars can be fully turned in both directions. If parts of the product come into contact with the tank or other vehicle components when the steering wheel is at full lock, repositioning the product or the handlebars is absolutely necessary! Make sure that the installation complies with the vehicle manufacturer's specifications! DO NOT ride your vehicle if the switch and control units are not functioning correctly or cannot be operated correctly! BEFORE every ride, carry out a complete functional check of the handlebars and all fittings!

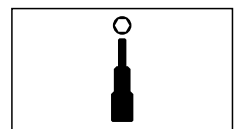
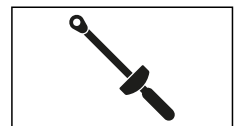

PRODUCT-SPECIFIC NOTES

⚠ NOTE: *Observe the country-specific regulations for the registration/operation of your vehicle or applicable TÜV regulations. After assembly, have parts that are subject to registration entered in the vehicle documents by your test centre.*

Item number: HDG.00.220.10300/B

Revision: 01 · Date: 12 - 2023

Sport handguard shell set

 ~ 0.25 h.

EASY      DIFFICULT

ENGLISH Thank you for choosing this premium product from SW-MOTECH. Visit our online shop for more information (e.g. model assignments). Required documents (e.g. national type approval) are available there for you to download.

Please read and understand all the instructions, safety information and warnings in these mounting instructions before mounting and using the product in order to avoid injury and damage. Keep these mounting instructions for reference.

This product was developed for vehicles in factory condition. Compatibility with original accessories or accessories from other manufacturers cannot be guaranteed.

These mounting instructions have been prepared to the best of our current knowledge. No legal claims relating to accuracy can be made. Errors and omissions excepted. We reserve the right to make technical and design changes. The copyright is held by SW-MOTECH.

SAFETY WARNING SYMBOL

 This warning symbol is used in these mounting instructions to warn of deadly dangers, injuries or other hazards. The words DANGER, WARNING or CAUTION are used as part of this warning symbol to convey important safety messages and information relating to the installation and use of this product. These words, together with the safety warning symbol, mean:

 **DANGER:** Indicates a hazardous situation which, if not avoided, will result in death or serious injury!

 **WARNING:** Indicates a hazardous situation which, if not avoided, may result in death or serious injury!

 **CAUTION:** Indicates a hazardous situation which, if not avoided, may result in minor or moderate injury!

 **NOTE:** Important information, but not relating to a risk of death or injury (property damage only)!

GENERAL INFORMATION

 **WARNING:** Assembly and/or maintenance of this product requires advanced technical skill, appropriate tools, and a good understanding of tool usage and torque specifications. For your own safety, SW-MOTECH recommends having the assembly and/or maintenance carried out by a qualified and certified motorcycle workshop.

 **WARNING:** If you do choose to assemble this product yourself, carefully and fully read the mounting instructions before assembly and use, and follow all instructions to avoid serious injury or death. Also observe all relevant information in the vehicle manual when mounting or using the product. IF YOU DO NOT UNDERSTAND ANY PART OF THESE MOUNTING INSTRUCTIONS OR NEED AN EXPLANATION AS TO A SPECIFIC INSTRUCTION, DO NOT ATTEMPT TO INSTALL THIS PRODUCT WITHOUT CONSULTING SW-MOTECH FOR ASSISTANCE!

PREPARATION: Read the mounting instructions carefully and make sure that all parts on the parts list are available.

 **CAUTION:** Ensure that your vehicle is standing securely. Switch off the engine and remove the ignition key. Allow the engine/exhaust to cool down if necessary. Disconnect the battery when working on the electrical system. Only use proper tools and always wear safety goggles and gloves during assembly and maintenance. Have a second person help you with assembly and maintenance.

ASSEMBLY: All parts and connections removed from the vehicle must be reinstalled according to the vehicle manufacturer's specifications or replaced with parts and hardware supplied by SW-MOTECH.

 **WARNING:** Secure all threads with a medium-strength liquid threadlocker, unless otherwise specified.

 **DANGER:** Tightening torques not defined by SW-MOTECH must be obtained from the vehicle manufacturer or a certified motorbike workshop.



FUNCTIONAL CHECK: After mounting the product, ensure that no moving parts are obstructed and that the function of the vehicle is not impeded. Cables and hoses must not rub against each other and/or be hindered in any way.

 **WARNING:** Carry out a comprehensive functionality check before you start to drive. Check the tightening torque of all connections and the tight fit of the product after the first 50 km and then at regular intervals. Mounted accessories can change the handling and stability of the vehicle.



SW-MOTECH GmbH & Co. KG
Ernteweg 7-10
35282 Rauschenberg
Germany



 info@sw-motech.com
 www.sw-motech.com

LEGEND OVERVIEW - READ AND KEEP MOUNTING INSTRUCTIONS!



Take note of the symbols and what they mean in the ASSEMBLY section. If the term OEM appears in the ASSEMBLY section, the vehicle manufacturer's specifications must be observed and applied.



If you have any questions, please don't hesitate to contact our Customer Service team or our distributors. You can find our telephone number and a list of our distributors in our online shop:
www.sw-motech.com



Do not use thread lock: Indicates that no liquid thread lock should be used at this point.



Tighten by hand: Indicates that the attachment must be carefully tightened by hand.

PARTS LIST - READ AND KEEP MOUNTING INSTRUCTIONS!

1

1



HDG.00.220.004L.02

 **1/1**

2



HDG.00.220.004R.02

 **1/1**

3



HDG.00.220.006.02

 **4/4**

4



M3,5 x 12
SC.ST.035.012.02

 **8/8**

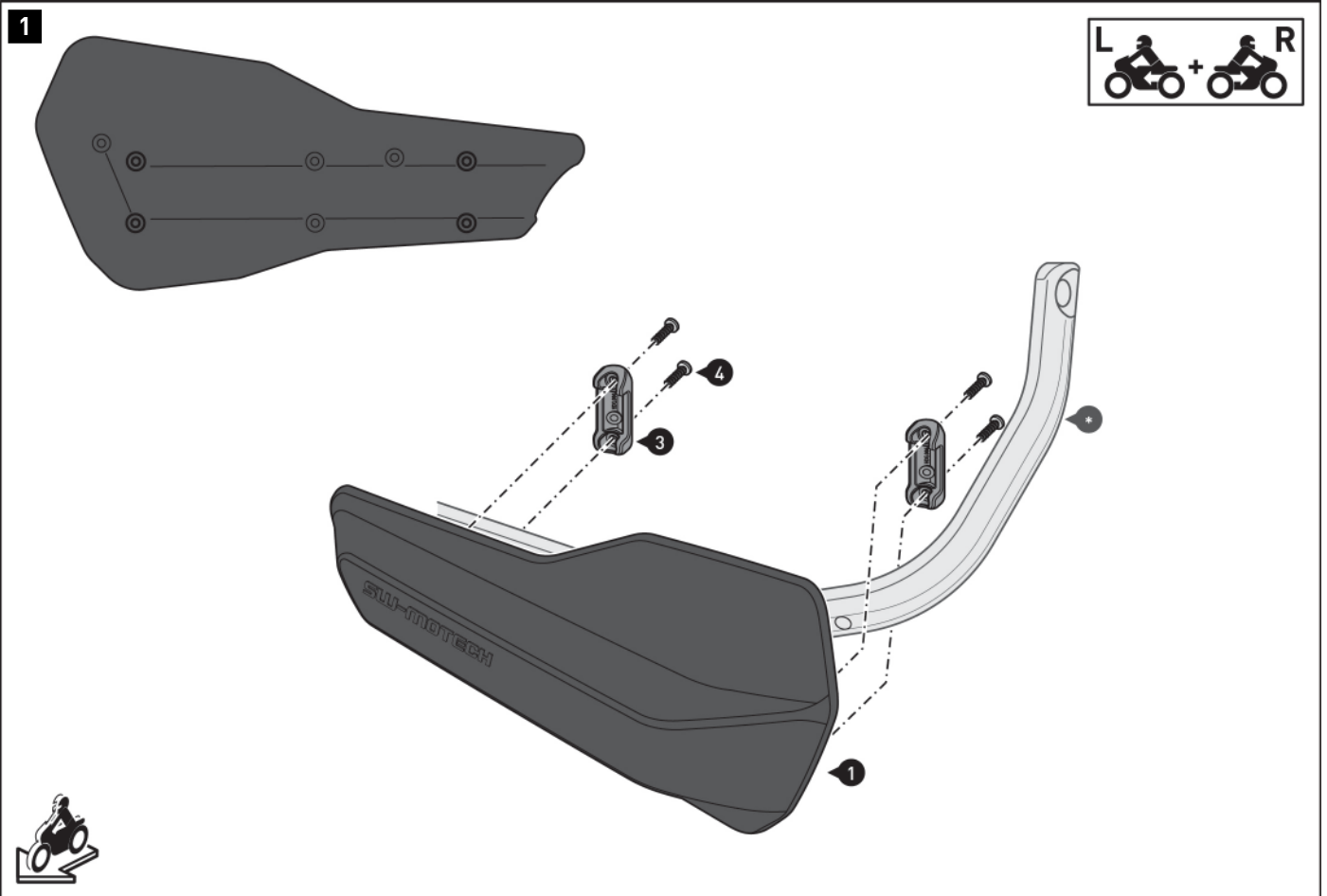

▲ WARNING: Always wear eye and hand protection!
▲ WARNING: Always use the proper tools!

▲ NOTE: Installation is shown on the left side. Repeat the installation with the corresponding parts on the right side of the handlebar.

Screw the sports hand-guard shells (1/2) onto the brackets (*). Carefully tighten the screws (4) hand-tight (max. 1 Nm).

▲ WARNING: Tightening too tightly can damage the plastic parts!

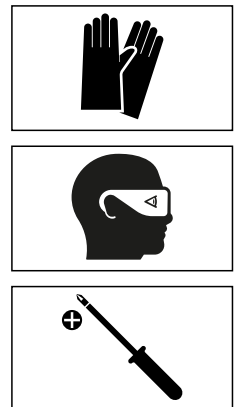
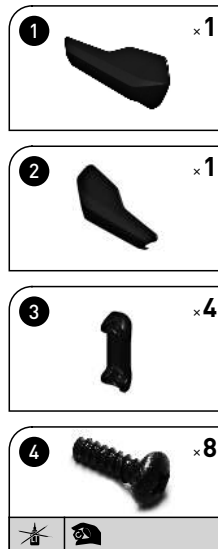

PRODUCT-SPECIFIC NOTES

⚠ NOTE: *Observe the country-specific regulations for the registration/operation of your vehicle or applicable TÜV regulations. After assembly, have parts that are subject to registration entered in the vehicle documents by your test centre.*

Art.-Nr. / Item No.: **STP.22.176.10302/B**

Revision: **00** · Datum / Date: **09 - 2022**

Sturzpad-Kit für Hinterachse

Slider set for rear axle

DEUTSCH · Vielen Dank, dass Sie sich für dieses Premium-Produkt von SW-MOTECH entschieden haben. Bitte lesen und verstehen Sie alle Anweisungen, Sicherheitshinweise und Warnungen in dieser Anbauanleitung vor Montage und Nutzung des Produkts, um Verletzungen zu vermeiden. Dieses Produkt wurde für Fahrzeuge im Werkszustand entwickelt. Die Kompatibilität mit Original-Zubehörteilen bzw. den Zubehörteilen anderer Hersteller kann nicht gewährleistet werden. Besuchen Sie unseren Webshop für weitere Informationen wie Modellzuweisungen und PDF-Anbauanleitung. Erforderliche Dokumente (z. B. ABE) stehen als Download zur Verfügung. Bewahren Sie diese Anbauanleitung als Referenz auf.

SW-MOTECH übernimmt keine Haftung für Schäden, die durch eine unsachgemäße Montage und/oder Wartung verursacht wurden!

SICHERHEITSWARNUNGSSYMBOL

⚠ Dieses Warnsymbol wird in dieser Anbauanleitung verwendet, um vor tödlichen Gefahren, Verletzungen oder anderen Gefahren zu warnen. Die Wörter **GEFAHR**, **WARNUNG** oder **VORSICHT** werden mit diesem Warnsymbol verwendet, um wichtige Sicherheitshinweise und Informationen in Bezug auf die Montage und Nutzung dieses Produkts zu übermitteln. Diese Wörter zusammen mit dem Sicherheitswarnsymbol bedeuten:

⚠ GEFAHR: Weist auf eine gefährliche Situation hin, die zum Tod oder zu schweren Verletzungen führt, wenn sie nicht vermieden wird!

⚠ WARNUNG: Weist auf eine gefährliche Situation hin, die zum Tod oder zu schweren Verletzungen führen kann, wenn sie nicht vermieden wird!

⚠ VORSICHT: Weist auf eine gefährliche Situation hin, die zu leichten oder mittelschweren Verletzungen führen kann, wenn sie nicht vermieden wird!

⚠ HINWEIS: Wichtige Informationen, jedoch nicht in Bezug auf Todes- oder Verletzungsgefahr (nur Sachschäden)!

⚠ WARNUNG: Die Montage und/oder Wartung dieses Produkts erfordert fortgeschrittene technische Fähigkeiten, passende Werkzeuge und ein gutes Verständnis der Werkzeugnutzung und Drehmomentangaben. Zu Ihrer Sicherheit empfiehlt SW-MOTECH, die Montage und/oder Wartung von einem qualifizierten und zertifizierten Zweiradmechaniker durchführen zu lassen.

⚠ WARNUNG: Wenn Sie sich für die Eigenmontage dieses Produkts entscheiden, lesen Sie vor Montage und Nutzung die Anbauanleitung sorgfältig und vollständig durch und befolgen Sie alle Anweisungen, um schwere oder tödliche Verletzungen zu vermeiden. Beachten Sie bei der Montage und Verwendung auch alle relevanten Informationen im Fahrzeughandbuch. **WENN SIE EINEN TEIL DIESER ANBAUANLEITUNG NICHT VERSTEHEN ODER EINE ERKLÄRUNG EINER ANWEISUNG BENÖTIGEN, VERSUCHEN SIE NICHT, DIESES PRODUKT ZU MONTIEREN OHNE SW-MOTECH UM HILFE ZU FRAGEN.**

VORBEREITUNG: Lesen Sie die Anbauanleitung aufmerksam und stellen Sie sicher, dass alle Teile der Stückliste vorhanden sind.

⚠ VORSICHT: Achten Sie auf den sicheren Stand Ihres Fahrzeugs. Schalten Sie den Motor ab und ziehen Sie den Zündschlüssel. Den Motor/Auspuff bei Bedarf abkühlen lassen. Klemmen Sie die Batterie bei Arbeiten an der Elektrik ab. Verwenden Sie geeignetes Werkzeuge und tragen Sie immer eine Schutzbrille und Handschuhe. Lassen Sie sich von einer zweiten Person helfen.

MONTAGE: Alle vom Fahrzeug entfernten Teile und Verbindungen müssen gemäß den Angaben des Fahrzeugherstellers wieder eingebaut oder durch von SW-MOTECH gelieferte Teile und Hardware ersetzt werden.

⚠ WARNUNG: Sichern Sie alle Gewinde, sofern nicht anders angegeben, mit mittelstarker, flüssiger Schraubensicherung. Von SW-MOTECH nicht definierte Drehmomentspezifikationen müssen vom Fahrzeughersteller oder von einer zertifizierten Motorradwerkstatt bezogen werden!

FUNKTIONSKONTROLLE: Stellen Sie nach der Montage sicher, dass keine beweglichen Teile blockiert und die Funktion des Fahrzeugs nicht gestört wird. Kabel und Schläuche dürfen nicht scheuern und/oder geklemmt werden.

⚠ WARNUNG: Führen Sie vor Fahrtbeginn eine umfassende Funktionskontrolle durch. Prüfen Sie nach den ersten 50 km und dann regelmäßig das Anzugsmoment aller Verbindungen und den festen Sitz des Produkts. Montiertes Zubehör kann Fahrverhalten/Stabilität des Fahrzeugs verändern.

ENGLISH · Thank you for choosing this premium product from SW-MOTECH. Please carefully read and understand all instructions, safety messages and warnings in this mounting instructions prior to installation and use of this product to avoid injury.

This product was developed for vehicles in their factory setting. Compatibility with original accessory parts or other manufacturers' accessory parts is not guaranteed. Visit our webshop for additional information, such as application charts and PDF mounting instructions. Any other documents that may be required (e.g. ABE certifications), are also available for download at our webshop. Keep these mounting instructions as reference.

SW-MOTECH assumes no liability for damage caused by improper installation and/or maintenance work!

SAFETY ALERT SYMBOL

⚠ This safety alert symbol is used throughout these mounting instructions to warn of the possibility of death, bodily injury or other warnings. The words **DANGER**, **WARNING** and **CAUTION** are used with this safety alert symbol to convey important safety messages and information related to the installation and use of this product. These words along with the safety alert symbol mean:

⚠ DANGER: Indicates a hazardous situation that, if not avoided, will result in death or serious injury!

⚠ WARNING: Indicates a hazardous situation that, if not avoided, could result in death or serious injury!

⚠ CAUTION: Indicates a hazardous situation that, if not avoided, could result in minor or moderate injury!

⚠ NOTICE: Important information, but not death or injury related (property damage only)!

⚠ WARNING: The installation and/or maintenance of this product requires advanced mechanical skills, the proper tools, and a thorough understanding of tool use and torque specifications.

For your own safety, SW-MOTECH recommends having installation and/or maintenance carried out by a qualified and certified motorcycle mechanic.

⚠ WARNING: Should you choose to self-install this product, carefully and completely read all intallation and safety instructions before installation and use, and follow all the directions and safety precautions given in the mounting instructions to avoid serious injury or death. Also pay attention to all relevant information in the vehicle manual during intallation and use. **IF YOU DO NOT UNDERSTAND ANY PART OF THESE INSTRUCTIONS, OR NEED CLARIFICATION OF ANY INSTRUCTION, DO NOT ATTEMPT TO MOUNT THIS PRODUCT WITHOUT CONTACTING SW-MOTECH FOR ASSISTANCE.**

PREPARATION: Read the mounting instructions carefully and make sure that all items of the parts list are included.

⚠ CAUTION: Make sure that your vehicle is parked safely and cannot fall over. Turn off the engine and remove the ignition key. Let the engine/exhaust cool off if necessary. Disconnect the vehicle battery when working on the electrical system. Use appropriate tools and wear always safety glasses and hand protection. Have another person help you.

MOUNTING: All parts and connections removed from the vehicle must be reinstalled in accordance with the vehicle manufacturer specifications or replaced by parts and hardware delivered by SW-MOTECH.

⚠ WARNING: Secure all threads, unless otherwise specified, with medium-strong strength liquid thread locker. Torque specifications undefined by SW-MOTECH must be obtained from the vehicle manufacturer or by a certified motorcycle workshop!

FUNCTION CHECK: After installation also make sure that no moving parts are obstructed, and function of the vehicle is not hindered in any way. Cables and hoses must not rub and/or be pinched.

⚠ WARNING: Before starting to ride, perform a comprehensive check of all functions. After the first 50 km and then at regular intervals, check the tightening torque of all connections and the proper fit of the product. Installed accessories can change driving behavior/stability of the vehicle.

Konfektionierung durch / Packed by:

Datum der Konfektionierung / Date of packaging:



SW-MOTECH GmbH & Co. KG
Ernteweg 7-10
35282 Rauschenberg
Germany

Tel. / phone + 49 (0)6425 / 8168 - 050
Fax / fax + 49 (0)6425 / 8168 - 10
info@sw-motech.com
www.sw-motech.com

STÜCKLISTE - ANBAUANLEITUNG LESEN UND AUFBEWAHREN / PARTS LIST - READ AND SAVE THESE MOUNTING INSTRUCTIONS

Schritt Step	Nr. No.	Art.-Nr. / Bezeichnung ^a Item No. / Description ^a	Artikel	Part	Anzahl ^b Quantity ^b	N·m ^c
1	(1)	GST.ST.08.405	Gewindestange; Länge 405 mm	Threaded Rod; length 405 mm	1 /1	
	(2)	STP.00.176.041	Buchse, gestuft; links; Höhe 30 mm	Spacer, stepped; left; height 30 mm	1 /1	
	(3)	STP.00.176.040	Buchse, gestuft; rechts; Höhe 20 mm	Spacer, stepped; right; height 20 mm	1 /1	
	(4)	ø 8,4; DIN 9021	Unterlegscheibe	Washer	1 /1	
	(5)	M8; DIN 439	Mutter, niedrige Form	Nut, low form	2 /2	18
2	(6)	STP.00.176.004	Sturzpad	Slider	2 /2	
	(7)	Ø 19 / ø 15,2 / h 4,4	Auflagebuchse; schwarz	Support Spacer; black	2 /2	
	(8)	ø 8,4; DIN 9021	Unterlegscheibe; schwarz	Washer; black	2 /2	
	(9)	M8; DIN 985	Mutter, selbstsichernd	Lock Nut	2 /2	18
3	(10)	STP.00.176.005 / ...006	Abdeckkappe mit Feder	Cover Cap with Spring	2 /2	

8.8	Regelgewinde / Coarse Thread Ø						N·m	M4	M5	M6	M8	M10	M12	10.9	Regelgewinde / Coarse Thread Ø						N·m	M4	M5	M6	M8	M10	M12
	Stahl FK 8.8 / Steel CL 8.8														Stahl FK 10.9 / Steel CL 10.9												
							2,8	5,5	9,6	23	46	79		4,1	8,1	14	34	67	115								

Anmerkungen: ^a Alle Maßangaben in Millimeter. ^b Der zweite Wert gibt die Gesamtanzahl des jew. Artikels in der Lieferung an. ^c **Keine Anzugsmomentvorgabe: Verwenden Sie das vom Fzg.-Hersteller definierte Anzugsmoment!** Das Std.-Anzugsmoment der Tabelle kann verwendet werden, wenn es den Fzg.-Hersteller-Vorgaben entspricht.

Note: ^a All measurements in millimeters. ^b The second number indicates the total quantity of the part in the delivery. ^c **No torque specifications: Use the torque defined by vehicle manufacturer!** The standard torque in this table can be used as long as it is within the vehicle manufacturer's specifications.

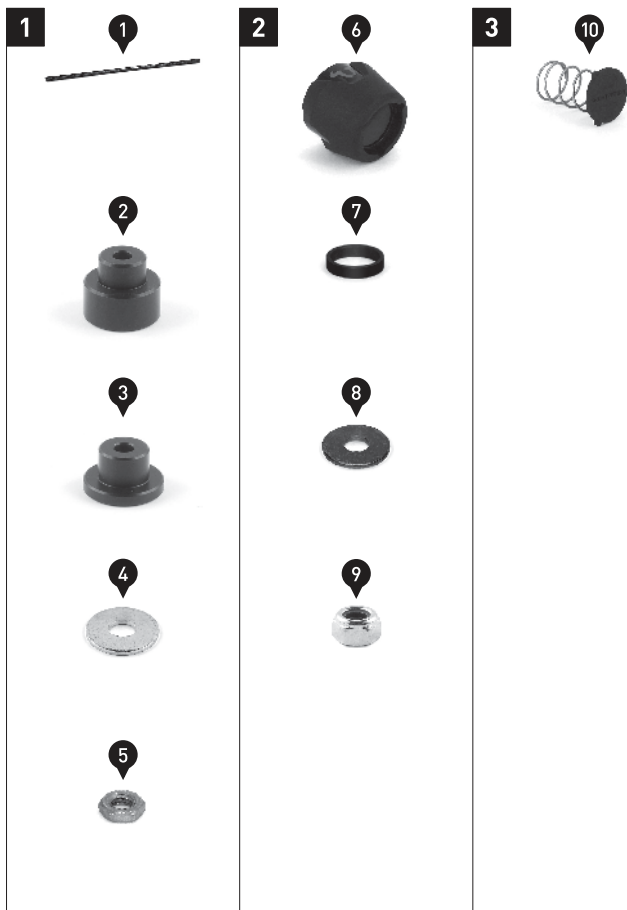

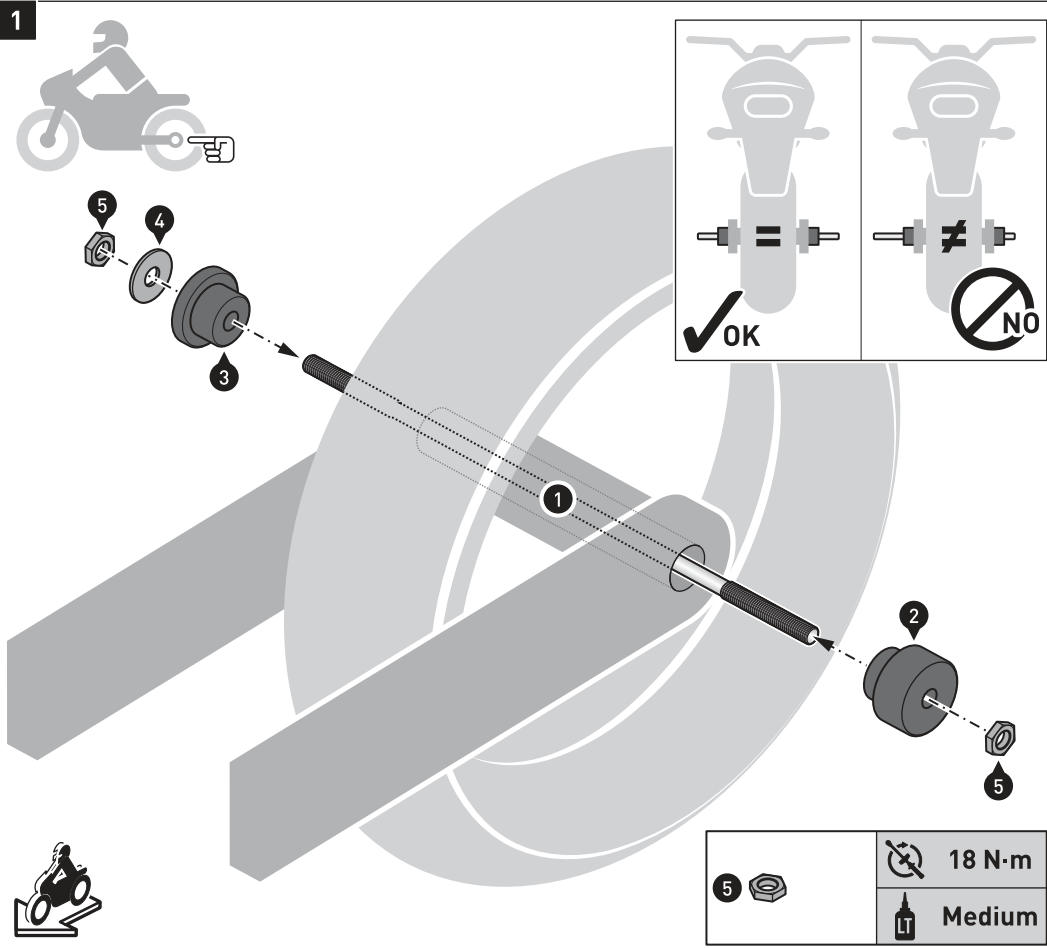

⚠ WARNING: Tragen Sie immer Augen- und Handschutz!

⚠ WARNING: Verwenden Sie immer geeignetes Werkzeug!

Führen Sie die Gewindestange (1) durch die **hintere** Achsaufnahme Ihres Fahrzeugs.

Stecken Sie nun die Buchsen (2) und (3) auf die Gewindestange (1) auf.

⚠ WARNING: Achten Sie auf die zentrierte Ausrichtung der Gewindestange (1)!

Montieren Sie anschließend die gezeigten Komponenten mit den Muttern (5) am Fahrzeug.

⚠ WARNING: Verwenden Sie flüssige Schraubensicherung! Ziehen Sie die Muttern (5) wie vorgegeben an.

⚠ WARNING: Always wear eye and hand protection!

⚠ WARNING: Always use appropriate tools!

Guide the threaded rod (1) through the **rear** axle mount of your vehicle.

Then plug the spacers (2) and (3) onto the threaded rod (1).

⚠ WARNING: Pay attention to the centered alignment of the threaded rod (1)!

Then mount the shown components with the nuts (5) to the vehicle.

⚠ WARNING: Use liquid thread locker!

Tighten the nuts (5) as specified.

5		18 N-m
		Medium

Das Fahrzeug dient als Beispiel. / Example vehicle shown.

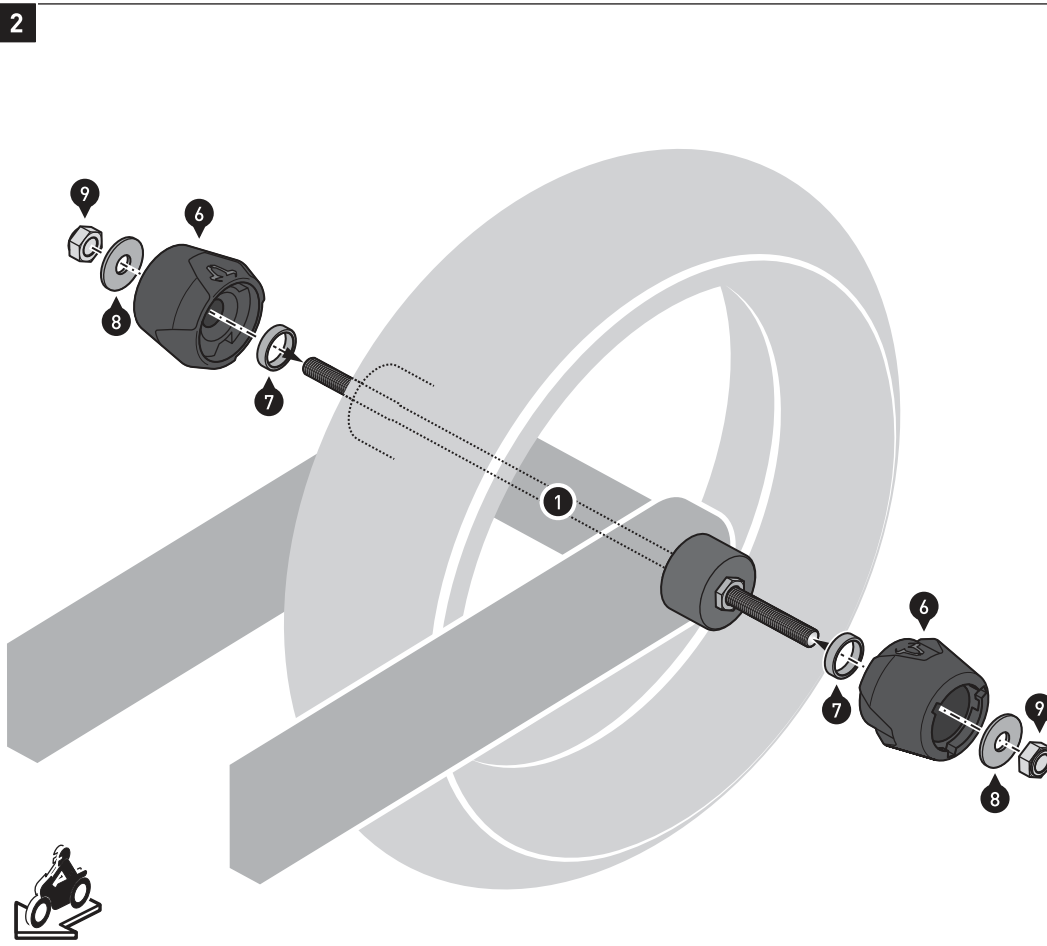

Montieren Sie die Sturz pads (6) mit den Muttern (9) **beidseitig** an der Gewindestange (1). Ziehen Sie die Muttern (9) wie vorgegeben an.

Mount the sliders (6) with the nuts (9) on **both sides** to the threaded rod (1).

Tighten the nuts (9) as specified.

9		18 N-m

Das Fahrzeug und die montierten Buchsen dienen als Beispiele. / The vehicle and the mounted spacers are examples.

3

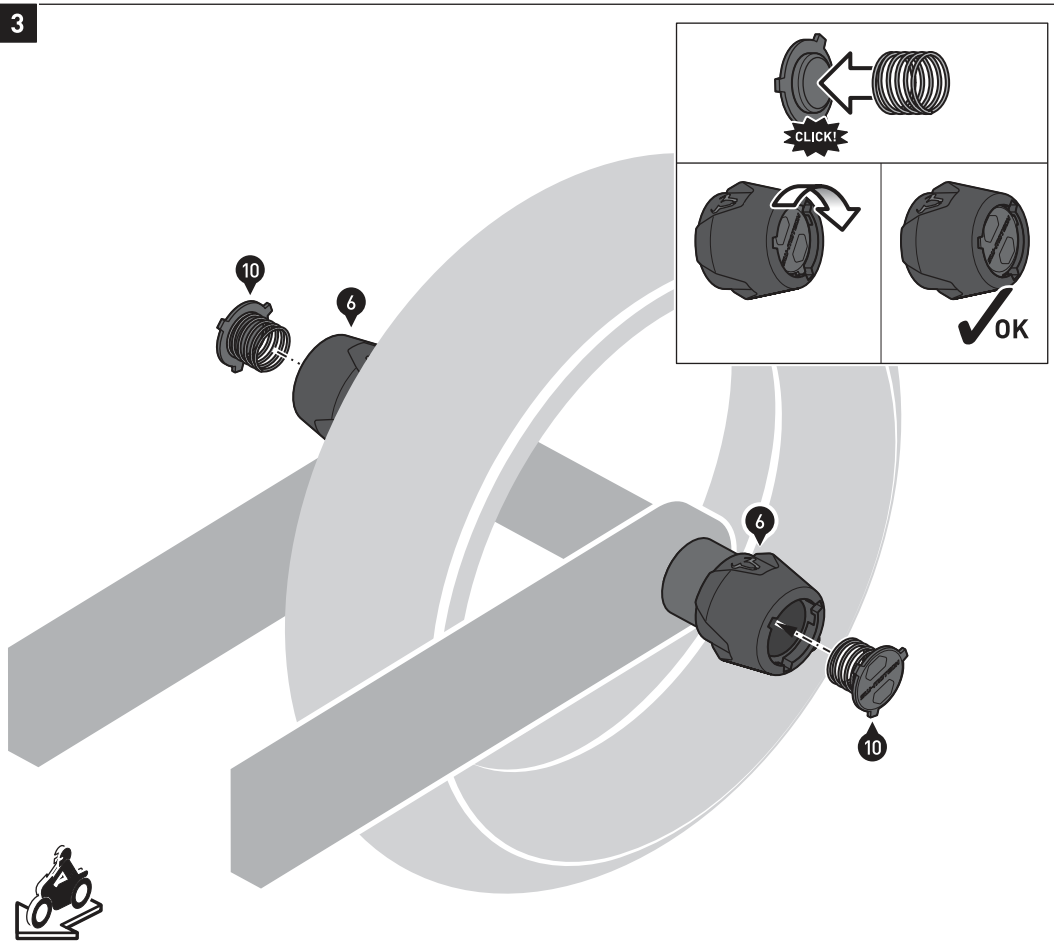

Das Fahrzeug und die montierten Buchsen dienen als Beispiele. / The vehicle and the mounted spacers are examples.

Setzen Sie **beidseitig** die Abdeckkappen (10) in die Öffnungen der montierten Sturzpads (6) ein und drehen Sie diese bis in die Endposition.

⚠️ WARNUNG: Achten Sie auf den festen Sitz der Abdeckkappen (10).

Insert the cover caps (10) on **both sides** into the openings of the mounted sliders (6) and turn them to their end position.

⚠️ WARNUNG: Make sure that the cover caps (10) fit firmly.

PRODUKTSPEZIFISCHE HINWEISE

⚠️ HINWEIS: Beachten Sie die landesspezifischen Vorschriften für Zulassung/Betrieb Ihres Fahrzeugs bzw. anwendbare TÜV-Vorschriften. Lassen Sie eintragungspflichtige Teile nach Montage durch Ihre Prüfstelle in die Fahrzeugpapiere eintragen.

PRODUCT SPECIFIC INFORMATION

⚠️ NOTICE: Observe the country-specific regulations concerning vehicle registration/operation as well as TÜV regulations if applicable. If required, register installed parts in the vehicle documents through an appropriate inspection authority.

Art.-Nr. / Item No.: **STP.22.176.10001/B**

Revision: **01** · Datum / Date: **11 - 2021**

Sturzpad-Kit für Vorderachse

Slider set for front axle

DEUTSCH - Vielen Dank, dass Sie sich für dieses Premium-Produkt von SW-MOTECH entschieden haben. Bitte besuchen Sie unseren Webshop für weitere Informationen wie Modellzuweisungen und PDF-Anbauanleitung. Erforderliche Dokumente (z. B. ABE) stehen als Download zur Verfügung.

Die Montage und/oder Wartung dieses Produkts erfordert ein gutes technisches Verständnis! Zu Ihrer eigenen Sicherheit empfiehlt SW-MOTECH, die Montage und/oder Wartung durch eine Fachwerkstatt durchführen zu lassen! SW-MOTECH übernimmt keine Haftung für Schäden, die durch eine unsachgemäße Montage und/oder Wartung verursacht wurden!

Beachten Sie alle in der Anbauanleitung angegebenen Hinweise und die für die Montage relevanten Informationen im Fahrzeughandbuch. Nichtbeachtung kann zu Schäden am Fahrzeug bzw. zur Gefährdung des Fahrers führen! Diese Anbauanleitung ist nach unserem derzeitigen Kenntnisstand verfasst worden. Rechtliche Ansprüche auf Richtigkeit bestehen nicht.

Dieses Produkt wurde für Fahrzeuge im Werkzustand entwickelt. Die Kompatibilität mit Original-Zubehörteilen bzw. den Zubehörteilen anderer Hersteller kann nicht gewährleistet werden. Stellen Sie des Weiteren VOR Montage dieses Produkts sicher, dass sich alle beweglichen Teile (z. B. die Kette) im ursprünglichen Wartungszustand befinden. Montiertes Zubehör kann das Fahrverhalten und/oder die Stabilität Ihres Fahrzeugs verändern.

ALLGEMEINE HINWEISE

Beachten Sie die landesspezifischen Vorschriften für Zulassung/Betrieb Ihres Fahrzeugs bzw. anwendbare TÜV-Vorschriften. Lassen Sie eintragungspflichtige Teile nach Montage durch Ihre Prüfstelle in die Fahrzeugpapiere eintragen.

VORBEREITUNG: Lesen Sie die Anbauanleitung aufmerksam und stellen Sie sicher, dass alle Teile der Stückliste vorhanden sind. Achten Sie darauf, dass Ihr Fahrzeug sicher steht und nicht umfallen kann. Schalten Sie den Motor ab und ziehen Sie den Zündschlüssel. Lassen Sie ggf. den Motor/Auspuff abkühlen. Klemmen Sie bei Arbeiten an der Elektrik die Fahrzeugbatterie ab. Verwenden Sie geeignetes Werkzeug. Lassen Sie sich von einer zweiten Person helfen.

MONTAGE: Alle vom Motorrad gelösten Teile und Verbindungen sind gemäß den Fahrzeugherstellereangaben wieder zu montieren oder durch die von SW-MOTECH gelieferten Teile zu ersetzen. Sichern Sie, falls nicht anderweitig definiert, alle Gewinde mit mittelfester, flüssiger Schraubensicherung.

Alle nicht durch SW-MOTECH definierten Anzugsmoment-Vorgaben müssen beim Fahrzeughersteller oder einer Fachwerkstatt erfragt werden!

FUNKTIONSKONTROLLE: Stellen Sie nach der Montage sicher, dass alle zuvor gelösten Teile und Verbindungen wieder ordnungsgemäß montiert wurden. Achten Sie außerdem auf die uneingeschränkte Freigängigkeit und einwandfreie Funktion sämtlicher Fahrzeugteile. Kabel, Züge und Schläuche dürfen nicht scheuern und/oder geklemmt werden. Führen Sie vor Fahrtbeginn eine umfassende Funktionskontrolle durch. Überprüfen Sie nach den ersten 50 km und anschließend in regelmäßigen Abständen das Anzugsmoment aller Schraubverbindungen und den ordnungsgemäßen Sitz des Produkts.

ENGLISH - Thank you for choosing this premium product from SW-MOTECH. Please visit our webshop for additional information, such as application charts and PDF mounting instructions. Any other documents that may be required (e.g. ABE certifications), are also available for download at our webshop.

Installation and/or maintenance of this product require good technical understanding! For your own safety SW-MOTECH recommends having installation and/or servicing carried out by a specialist workshop! SW-MOTECH assumes no liability for damage caused by improper installation and/or maintenance work!

Carefully follow all the directions given in the mounting instructions and pay attention to all relevant information in the vehicle manual during assembly. Nonconformance can lead to vehicle damage or even endanger the driver! These mounting instructions are written based on our current state of knowledge. Legal requirements for accuracy do not exist.

This product was developed for vehicles in their factory setting. Compatibility with original accessory parts or other manufacturers' accessory parts is not guaranteed. Furthermore, BEFORE installing this product, make sure that all moving parts (e.g. the chain) are in the original state of maintenance. Installed accessories can change the driving behaviour and/or stability of your vehicle.

GENERAL INFORMATION

Observe the country-specific regulations concerning vehicle registration/operation as well as TÜV regulations if applicable. If required, register installed parts in the vehicle documents through an appropriate inspection authority.

PREPARATION: Read the mounting instructions carefully and make sure that all items of the parts list are included. Make sure that your vehicle is parked safely and cannot fall over. Turn off the engine and remove the ignition key. Let the motor/exhaust cool off if necessary. Disconnect the vehicle battery when working on the electrical system. Use appropriate tools. Have another person to help you.

MOUNTING: All parts and connections removed from the vehicle must be reinstalled in accordance with the vehicle manufacturers' specifications or replaced by parts delivered by SW-MOTECH. Secure all threads, unless otherwise specified, with medium-strength liquid thread locker.

Torque specifications undefined by SW-MOTECH must be obtained from the vehicle manufacturer or by a specialist workshop!

FUNCTION CHECK: After installation make sure that all parts and connections previously removed are properly replaced. Also make sure that no moving parts are obstructed and no function of the vehicle is hindered in any way. Cables and hoses must not rub and/or be pinched. Before starting to ride, perform a comprehensive check of all functions. After the first 50 km and then at regular intervals, check the tightening torque of all screw connections and the proper fit of the product.

Konfektionierung durch / Packed by:

Datum der Konfektionierung / Date of packaging:



SW-MOTECH GmbH & Co. KG
Ernteweg 7-10
35282 Rauschenberg
Germany

Tel. / phone + 49 (0)6425 / 8168 - 050
Fax / fax + 49 (0)6425 / 8168 - 10
info@sw-motech.com
www.sw-motech.com

MONTAGE / MOUNTING

1

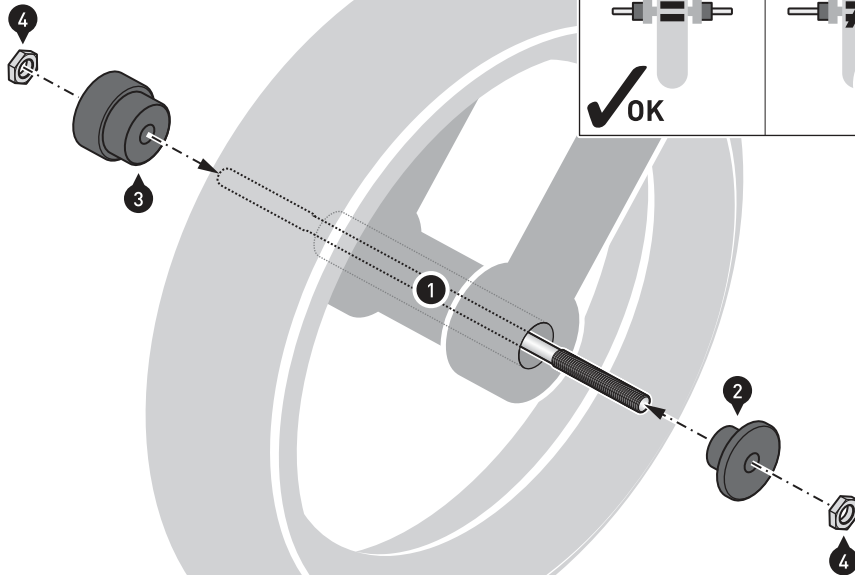

Führen Sie die Gewindestange (1) durch die **vordere** Achsaufnahme Ihres Fahrzeugs.

Stecken Sie nun die Buchsen (2) und (3) auf die Gewindestange (1) auf, wie in der Zeichnung gezeigt.

ACHTUNG: Achten Sie auf die zentrierte Ausrichtung der Gewindestange (1)!

Montieren Sie anschließend die gezeigten Komponenten mit den Muttern (4) am Fahrzeug.

ACHTUNG: Verwenden Sie flüssige Schraubensicherung!

Ziehen Sie die Muttern (4) wie vorgegeben an.

Guide the threaded rod (1) through the **front** axle mount of your vehicle.

Then plug the spacers (2) and (3) onto the threaded rod (1), as shown in the drawing.

ATTENTION: Pay attention to the centered alignment of the threaded rod (1)!

Then mount the shown components with the nuts (4) to the vehicle.

ATTENTION: Use liquid thread locker!

Tighten the nuts (4) as specified.



18 N·m



Medium



Das Fahrzeug dient als Beispiel. / Example vehicle shown.

2

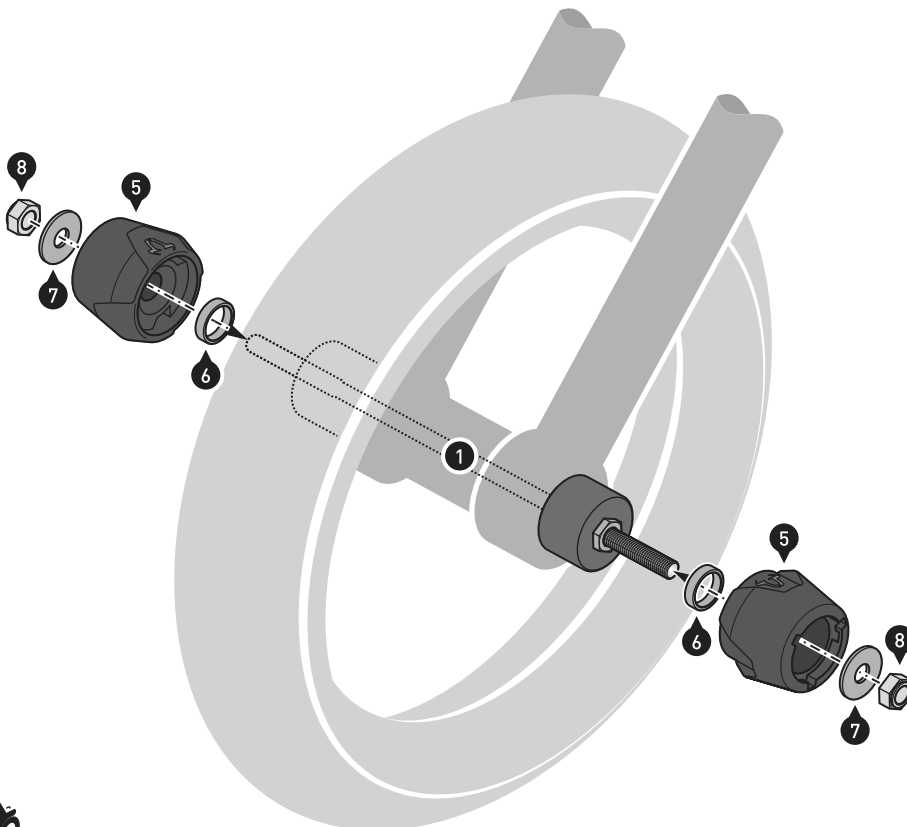

Montieren Sie die Sturz pads (5) mit den Muttern (8) **beidseitig** an der Gewindestange (1).

Ziehen Sie die Muttern (8) wie vorgegeben an.

Mount the sliders (5) with the nuts (8) on **both sides** to the threaded rod (1).

Tighten the nuts (8) as specified.



18 N·m



Das Fahrzeug und die montierten Buchsen dienen als Beispiele. / The vehicle and the mounted spacers are examples.

3

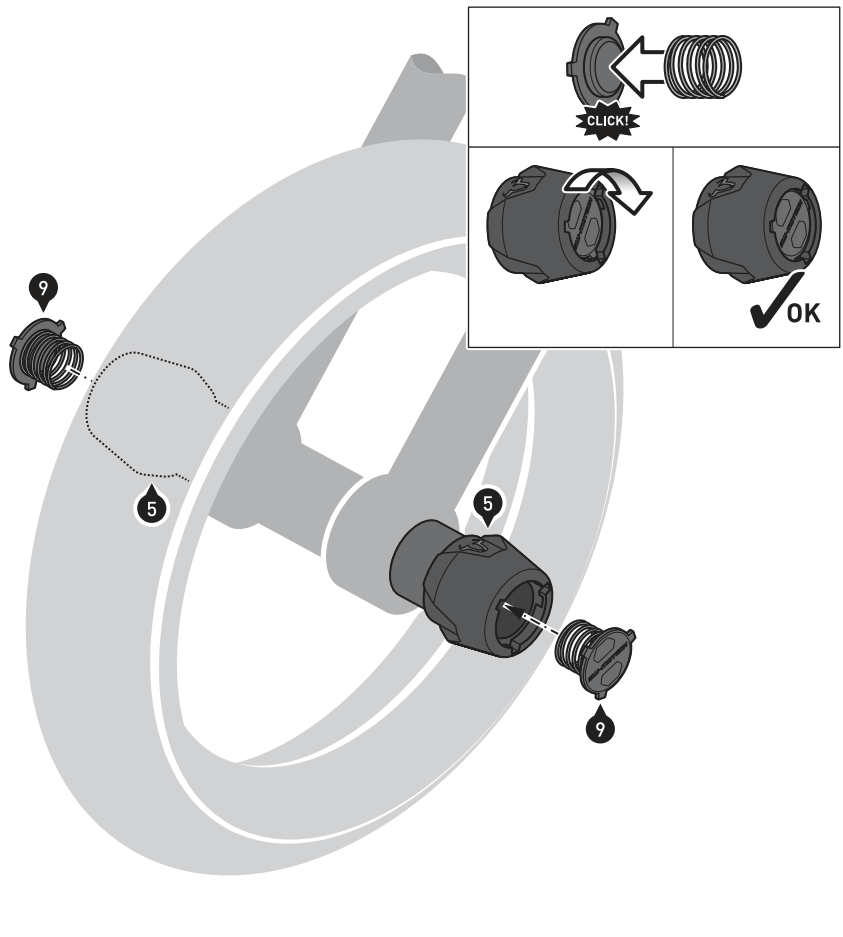

Setzen Sie **beidseitig** die Abdeckkappen (9) in die Öffnungen der montierten Sturz pads (5) ein und drehen Sie diese bis in die Endposition.
ACHTUNG: Achten Sie auf den festen Sitz der Abdeckkappen (9).

Insert the cover caps (9) on **both sides** into the openings of the mounted sliders (5) and turn them to their end position.
ATTENTION: Make sure that the cover caps (9) fit firmly.



Das Fahrzeug und die montierten Buchsen dienen als Beispiele. / The vehicle and the mounted spacers are examples.