

ANBAUANLEITUNG

mounting instructions • instructions de montage • instrucciones de montaje • istruzioni di montaggio

GPT.07.975.70000/S

beinhaltet • contains • contient • contiene • contiene

GPT.07.975.19000/B

GPT.00.152.35100/B

ALK.00.733.15000/S

ALK.00.165.16503

Item number: **GPT.07.975.19000/B**

Revision: **00** · Date: **11 - 2023**

ADVENTURE-RACK

 ~ 1 h.

EASY      DIFFICULT

ENGLISH Thank you for choosing this premium product from SW-MOTECH. Visit our online shop for more information (e.g. model assignments). Required documents (e.g. national type approval) are available there for you to download.

Please read and understand all the instructions, safety information and warnings in these mounting instructions before mounting and using the product in order to avoid injury and damage. Keep these mounting instructions for reference.

This product was developed for vehicles in factory condition. Compatibility with original accessories or accessories from other manufacturers cannot be guaranteed.

These mounting instructions have been prepared to the best of our current knowledge. No legal claims relating to accuracy can be made. Errors and omissions excepted. We reserve the right to make technical and design changes. The copyright is held by SW-MOTECH.

SAFETY WARNING SYMBOL

 This warning symbol is used in these mounting instructions to warn of deadly dangers, injuries or other hazards. The words **DANGER**, **WARNING** or **CAUTION** are used as part of this warning symbol to convey important safety messages and information relating to the installation and use of this product. These words, together with the safety warning symbol, mean:

 **DANGER:** Indicates a hazardous situation which, if not avoided, will result in death or serious injury!

 **WARNING:** Indicates a hazardous situation which, if not avoided, may result in death or serious injury!

 **CAUTION:** Indicates a hazardous situation which, if not avoided, may result in minor or moderate injury!

 **NOTE:** Important information, but not relating to a risk of death or injury (property damage only)!

GENERAL INFORMATION

 **WARNING:** Assembly and/or maintenance of this product requires advanced technical skill, appropriate tools, and a good understanding of tool usage and torque specifications. For your own safety, SW-MOTECH recommends having the assembly and/or maintenance carried out by a qualified and certified motorcycle workshop.

 **WARNING:** If you do choose to assemble this product yourself, carefully and fully read the mounting instructions before assembly and use, and follow all instructions to avoid serious injury or death. Also observe all relevant information in the vehicle manual when mounting or using the product. **IF YOU DO NOT UNDERSTAND ANY PART OF THESE MOUNTING INSTRUCTIONS OR NEED AN EXPLANATION AS TO A SPECIFIC INSTRUCTION, DO NOT ATTEMPT TO INSTALL THIS PRODUCT WITHOUT CONSULTING SW-MOTECH FOR ASSISTANCE!**

PREPARATION: Read the mounting instructions carefully and make sure that all parts on the parts list are available.

 **CAUTION:** Ensure that your vehicle is standing securely. Switch off the engine and remove the ignition key. Allow the engine/exhaust to cool down if necessary. Disconnect the battery when working on the electrical system. Only use proper tools and always wear safety goggles and gloves during assembly and maintenance. Have a second person help you with assembly and maintenance.

ASSEMBLY: All parts and connections removed from the vehicle must be reinstalled according to the vehicle manufacturer's specifications or replaced with parts and hardware supplied by SW-MOTECH.

 **WARNING:** Secure all threads with a medium-strength liquid threadlocker, unless otherwise specified.

 **DANGER:** Tightening torques not defined by SW-MOTECH must be obtained from the vehicle manufacturer or a certified motorbike workshop.

FUNCTIONAL CHECK: After mounting the product, ensure that no moving parts are obstructed and that the function of the vehicle is not impeded. Cables and hoses must not rub against each other and/or be hindered in any way.

 **WARNING:** Carry out a comprehensive functionality check before you start to drive. Check the tightening torque of all connections and the tight fit of the product after the first 50 km and then at regular intervals. Mounted accessories can change the handling and stability of the vehicle.



SW-MOTECH GmbH & Co. KG
Ernteweg 7-10
35282 Rauschenberg
Germany



 info@sw-motech.com
 www.sw-motech.com



Take note of the symbols and what they mean in the ASSEMBLY section. If the term OEM appears in the ASSEMBLY section, the vehicle manufacturer's specifications must be observed and applied.



If you have any questions, please don't hesitate to contact our Customer Service team or our distributors. You can find our telephone number and a list of our distributors in our online shop:

www.sw-motech.com













































Use thread locker: Indicates that a thread must be coated with liquid thread locker. H (HIGH): high strength; M (MEDIUM): medium strength; L (LOW): low strength.



Tighten/note the tightening torque information:

Indicates the tightening torque of a part specified by SW-MOTECH or the vehicle manufacturer (OEM).

PARTS LIST - READ AND KEEP MOUNTING INSTRUCTIONS!

<p>2</p>	<p>1</p>  <p>GPT.07.975.903.01.11</p> <p> 1/1</p>	<p>2</p>  <p>GPT.07.975.904.01.11</p> <p> 1/1</p>	<p>3</p>  <p>M8 x 35; ISO 7380 SC.ST.08.035.02.7380.109</p> <p> 2/2</p>	<p>4</p>  <p>M8 x 40; ISO 7380 SC.ST.08.040.02.7380.109</p> <p> 2/2</p>		
<p>3</p>	<p>5</p>  <p>GPT.07.975.002.11</p> <p> 1/1</p>	<p>6</p>  <p>M4 x 8; ISO 7380 SC.ST.04.008.02.73800.109</p> <p> 4/4</p>				
<p>4</p>	<p>7</p>  <p>GPT.07.975.901.01.11</p> <p> 1/1</p>	<p>8</p>  <p>GPT.07.975.902.01.11</p> <p> 1/1</p>	<p>9</p>  <p>M8 x 25; DIN 6912 SC.ST.08.025.02.6912.088</p> <p> 2/2</p>	<p>10</p>  <p>ø 8,4; DIN 125 US.ST.084.02.125</p> <p> 2/2</p>	<p>11</p>  <p>M8 x 60; DIN 6912 SC.ST.08.060.02.6912.088</p> <p> 2/2</p>	<p>12</p>  <p>Ø 20 / ø 8,2 / h 3 DB.00.200.082.003.01</p> <p> 2/2</p>
	<p>13</p>  <p>KFT.05.294.002</p> <p> 2/2</p>	<p>14</p>  <p>KES.RD.210.0300.02.GL</p> <p> 2/2</p>				
<p>5</p>	<p>15</p>  <p>GPT.00.152.002.11</p> <p> 1/1</p>	<p>16</p>  <p>M6 x 20; DIN 7380 SC.ST.06.020.02.7380.109</p> <p> 4/4</p>	<p>17</p>  <p>ø 6,4; DIN 9021 US.ST.064.02.9021</p> <p> 4/4</p>	<p>18</p>  <p>M6; DIN 6927 MU.ST.06.02.6927.08</p> <p> 4/4</p>	<p>19</p>  <p>SBL.00.051.013.02</p> <p> 2/2</p>	<p>20</p>  <p>Ø 22 / ø 8,4 / h 6 DB.ST.0220.0084.0060.02</p> <p> 2/2</p>
	<p>21</p>  <p>Ø 18 / ø 8,4 / h 15 DB.ST.0180.0084.0150.02</p> <p> 2/2</p>					

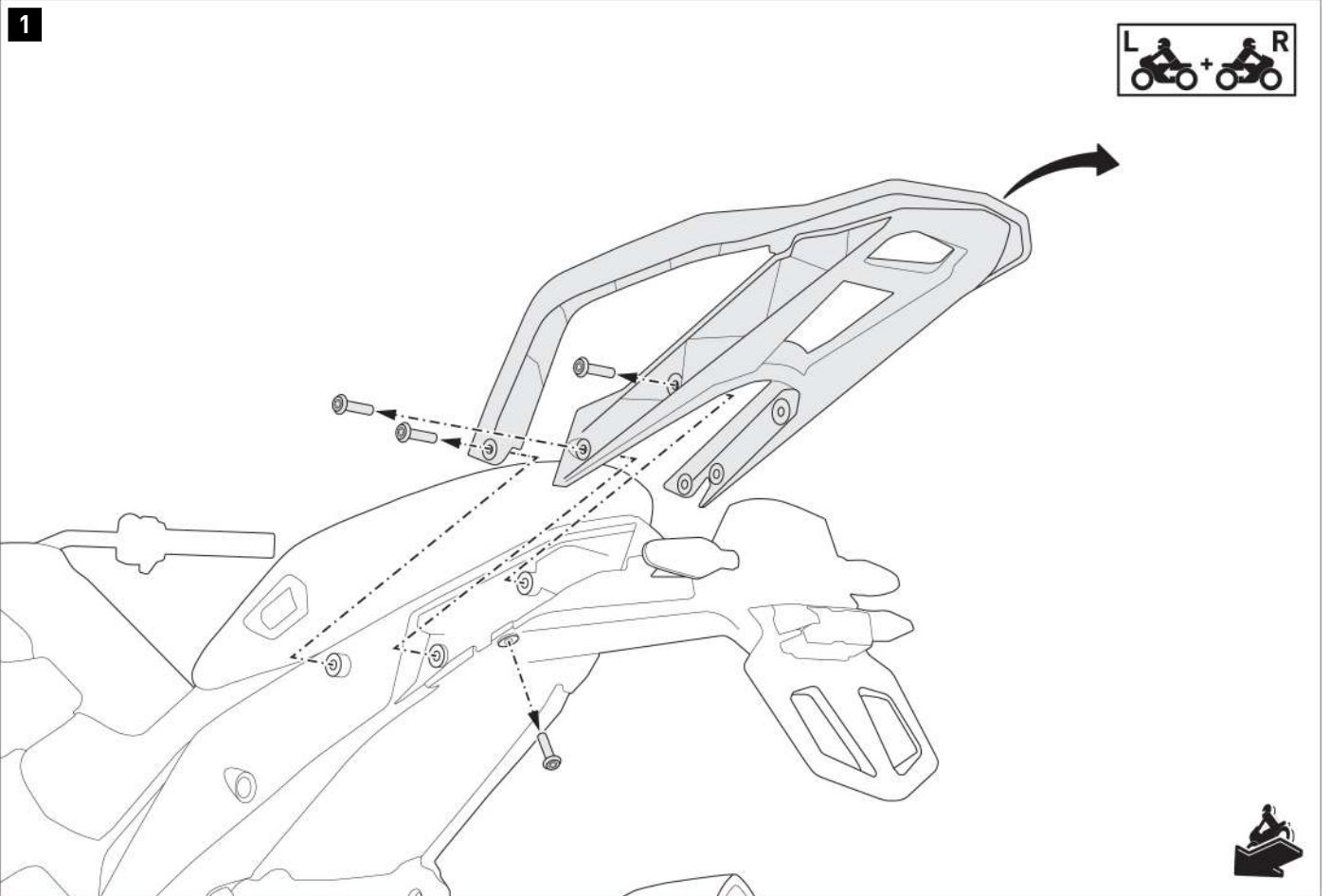

- ⚠ **WARNING: Always wear eye and hand protection!**
- ⚠ **WARNING: Always use the proper tools!**
- ⚠ **NOTE: Disassembly and assembly are carried out on the same side!**

Loosen the screws on the original rack, and remove it.

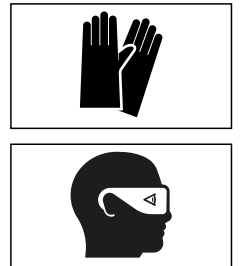

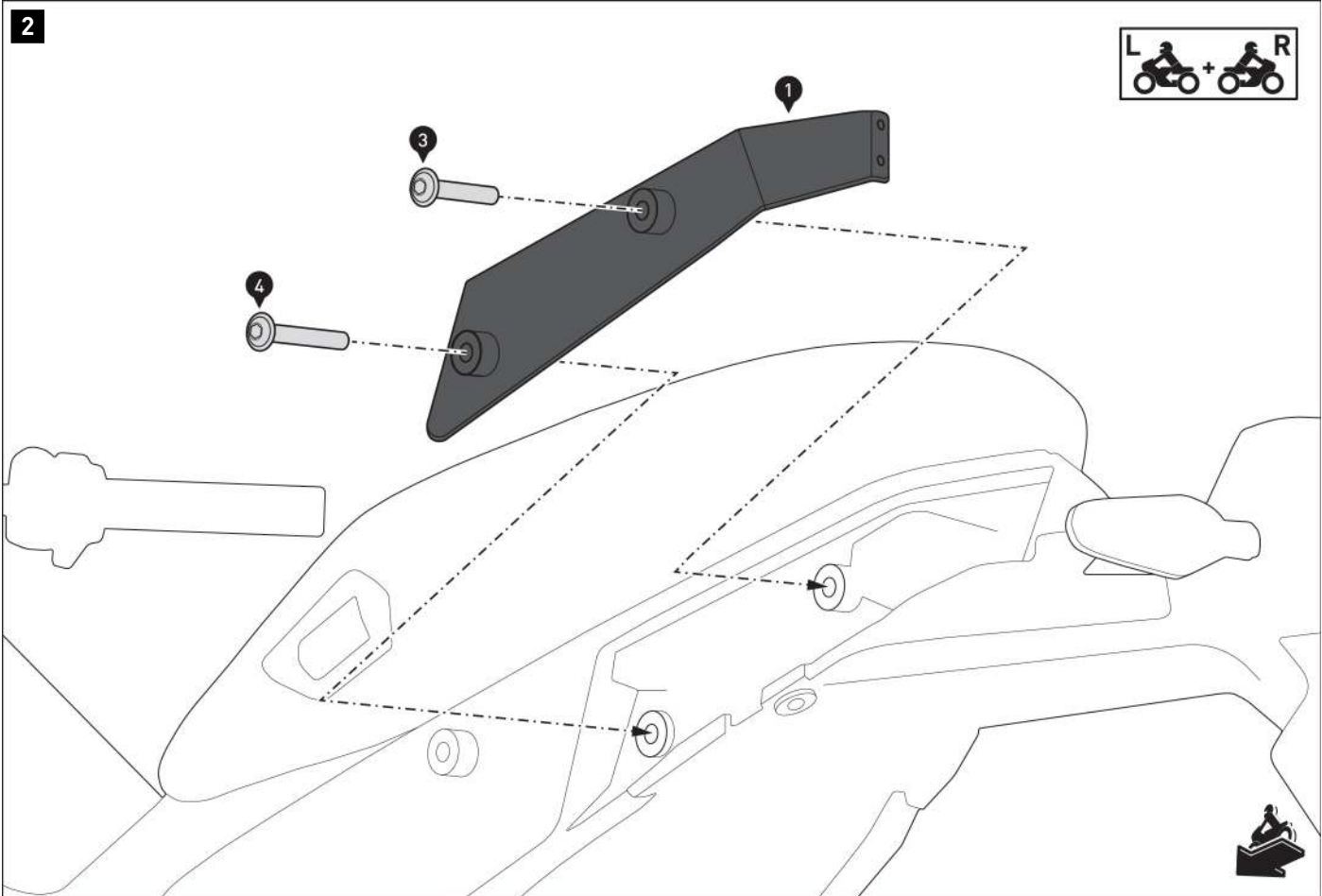

Mount the cover plates (1) and (2) on both sides of the vehicle.
▲ WARNING: Use a liquid threadlocker!
 Do not tighten the screws (3) and (4) yet.

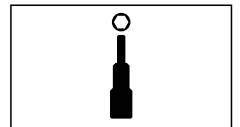
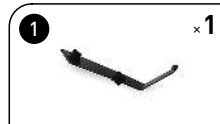

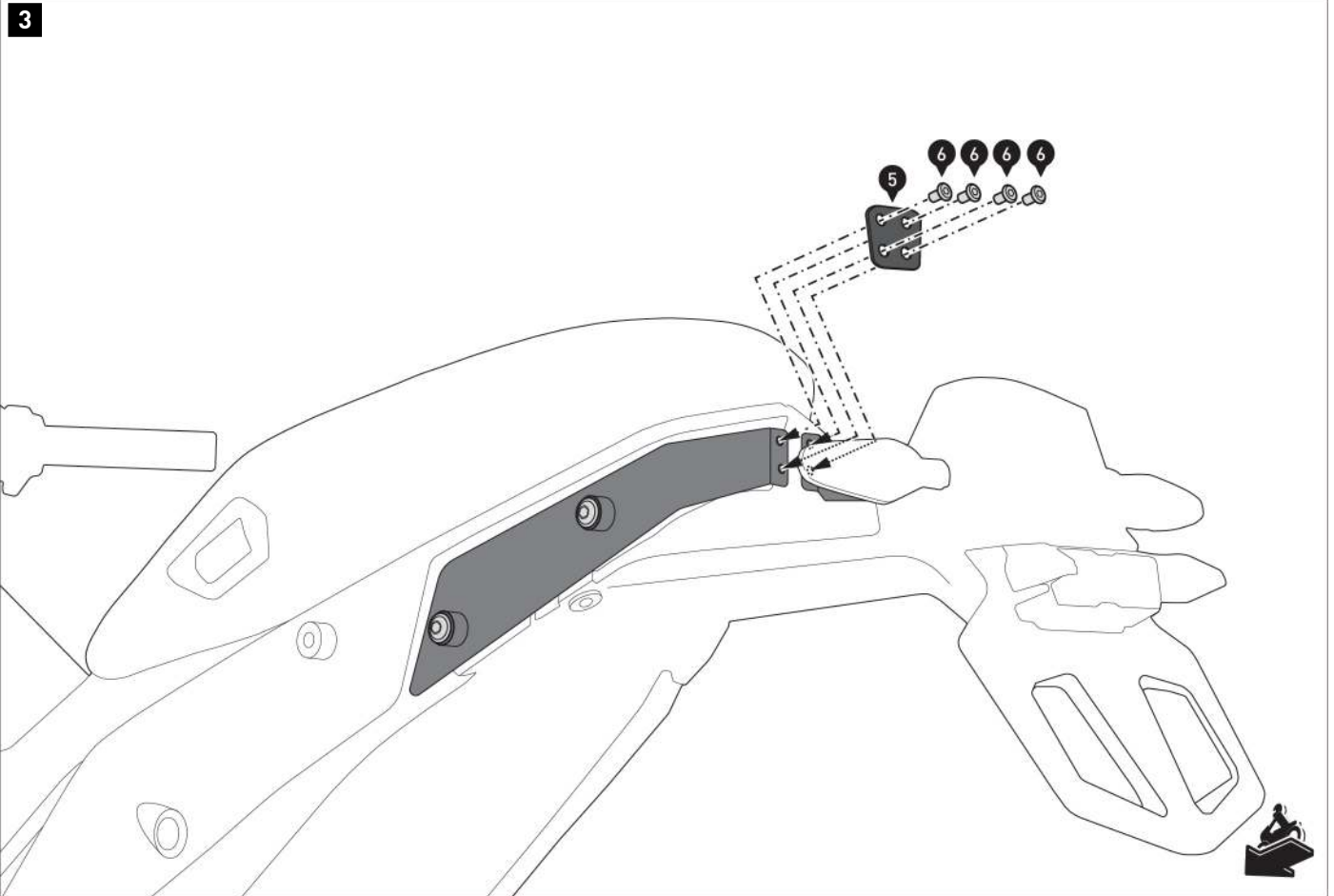

Connect the cover plates (1) and (2) to the connecting plate (5).
▲ WARNING: Use liquid thread locker.
 Tighten the screws (3), (4), and (6) as specified in the mounting instructions.

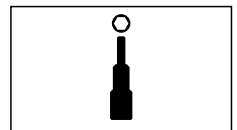
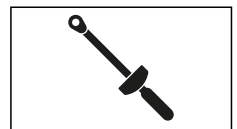
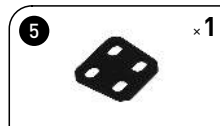

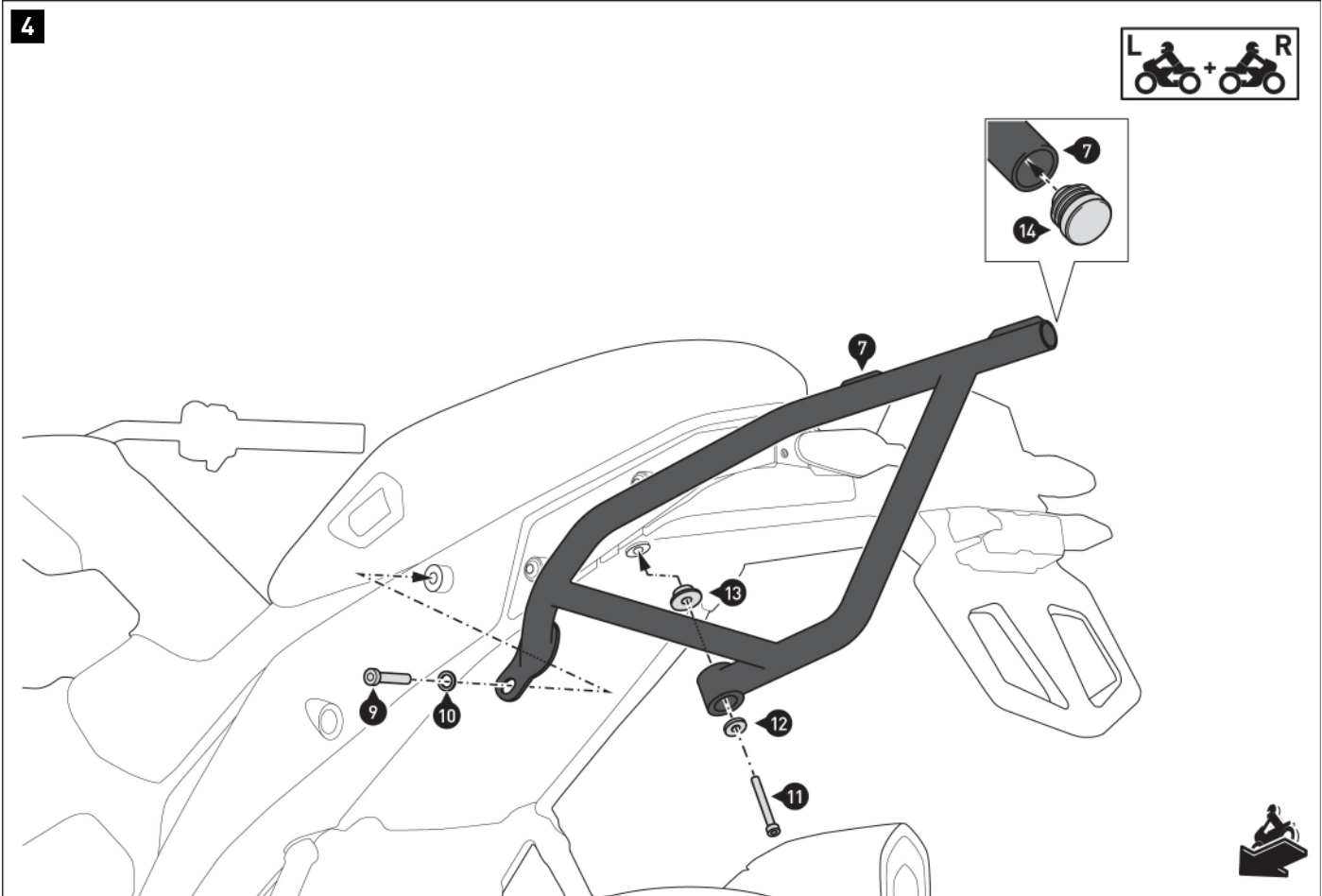

Insert the plastic plugs (14) into the ends of the mounting struts (7/8).

Screw the mounting struts (7/8) onto both sides of the vehicle.

▲ WARNING: Use liquid thread locker.
Do not tighten the screws (9) and (11) yet.

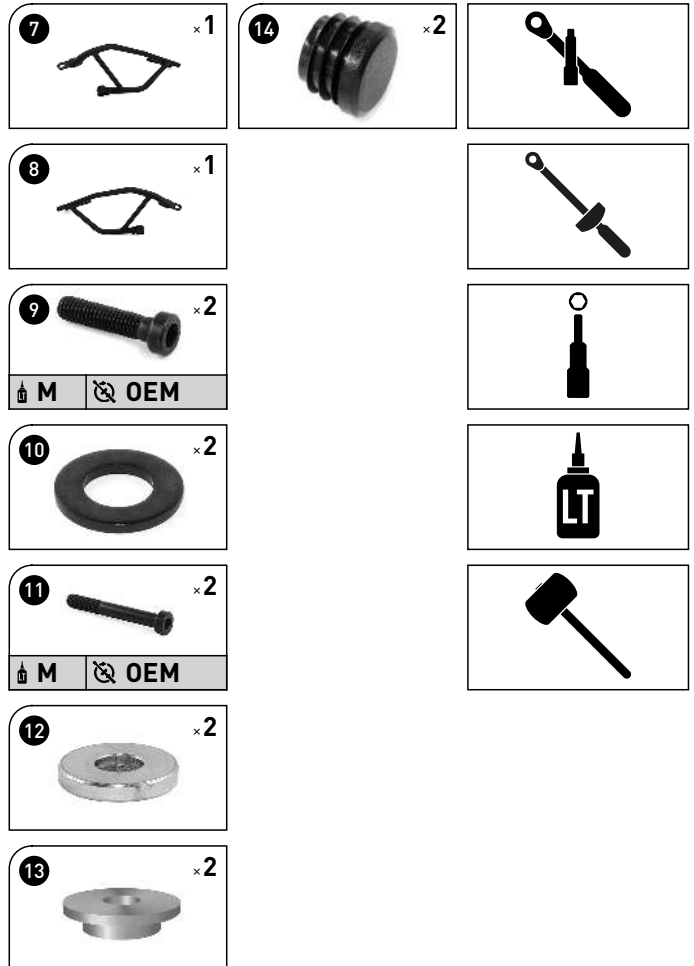

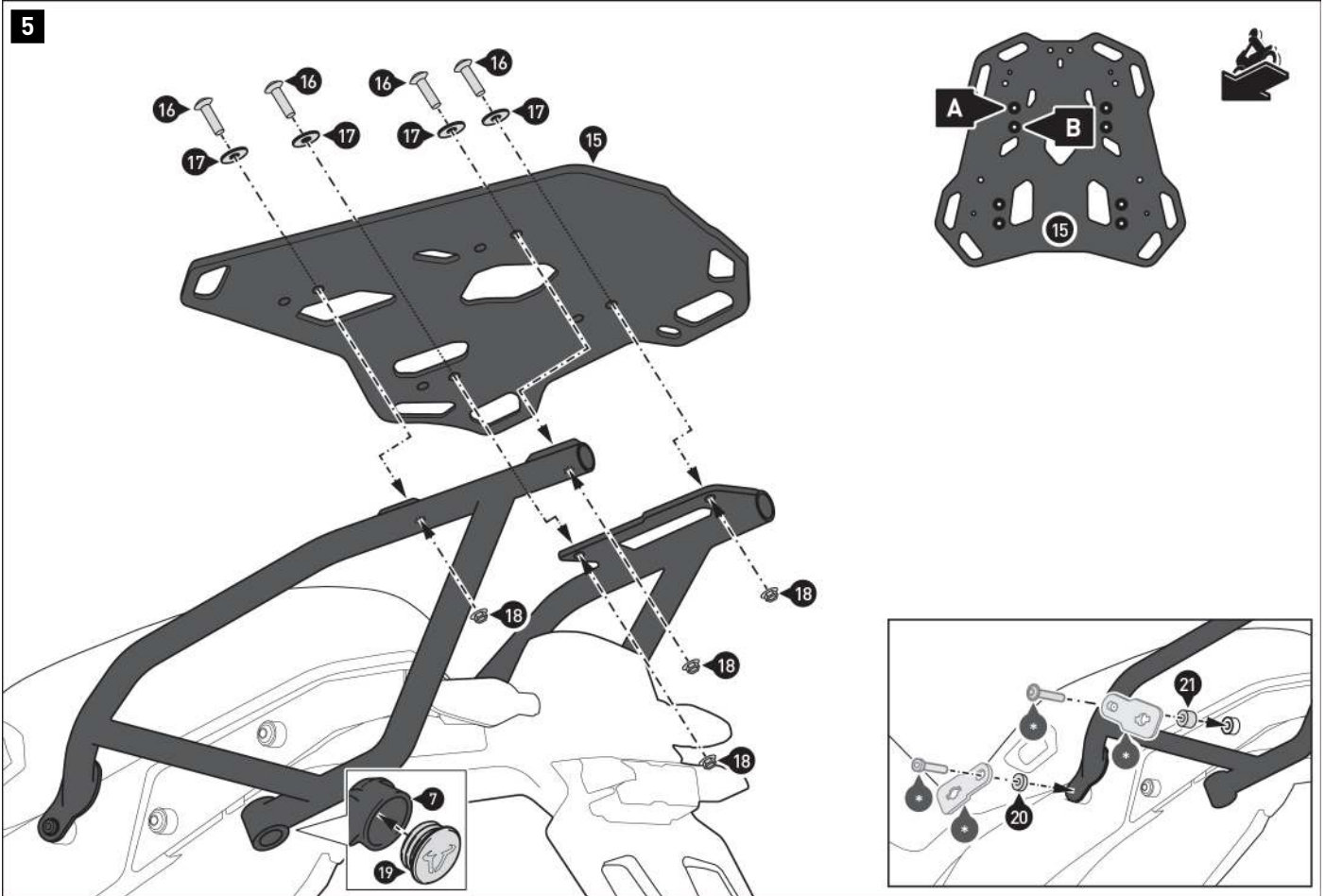

⚠ NOTE: If the SW-MOTECH side carrier is installed at the same time, screws (3) and (9) are omitted. In their place, mount the screws (*) included with the side carrier as shown in the detailed drawing below.

⚠ NOTE: Depending on the space available, screw the rack to the marked mounting position (A) or (B) as shown in the detailed drawing above.

Mount the rack (15) on the mounting struts (7) and (8). Then tighten the screws (16) as specified in the mounting instructions.

Once all components are in place without tension, tighten the screws (9) and (13) according to the manufacturer's instructions.

Place the plastic plugs (19) into the mounting struts (7) and (8).

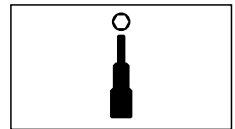
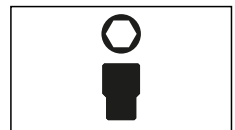
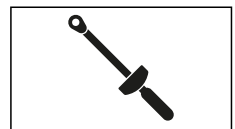

PRODUCT-SPECIFIC NOTES

⚠ WARNING: The specified maximum load includes the weight of the case/luggage and adapter plate/adapter kit! The maximum vehicle load specified by the vehicle manufacturer applies!



≤ 12 KG (≤ 26 lbs)



≤ 130 km/h (≤ 80 mph)

⚠ NOTE: Ensure you adhere to country-specific regulations regarding the registration and operation of your vehicle or any applicable TÜV regulations. After assembly, parts that are subject to registration should be entered in the vehicle documents by your test center.

Art.-Nr. / Item No.: GPT.00.152.35100/B

Revision: 00 · Datum / Date: 01 - 2018

**Adapterkit für ADVENTURE-/STREET-RACK
Gepäckträger – TRAX****Adapter kit for ADVENTURE-/STREET-RACK
– TRAX**

DEUTSCH - Vielen Dank, dass Sie sich für dieses Premium-Produkt von SW-MOTECH entschieden haben. Bitte besuchen Sie unseren Webshop für weitere Informationen wie Modellzuweisungen und PDF-Anbauanleitung. Erforderliche Dokumente (z. B. ABE) stehen als Download zur Verfügung.

Die Montage und/oder Wartung dieses Produkts erfordert ein gutes technisches Verständnis! Zu Ihrer eigenen Sicherheit empfiehlt SW-MOTECH, die Montage und/oder Wartung durch eine Fachwerkstatt durchführen zu lassen! SW-MOTECH übernimmt keine Haftung für Schäden, die durch eine unsachgemäße Montage und/oder Wartung verursacht wurden!

Beachten Sie alle in der Anbauanleitung angegebenen Hinweise und die für die Montage relevanten Informationen im Fahrzeughandbuch. Nichtbeachtung kann zu Schäden am Fahrzeug bzw. zur Gefährdung des Fahrers führen! Diese Anbauanleitung ist nach unserem derzeitigen Kenntnisstand verfasst worden. Rechtliche Ansprüche auf Richtigkeit bestehen nicht.

Dieses Produkt wurde für Fahrzeuge im Werkzustand entwickelt. Die Kompatibilität mit Original-Zubehörteilen bzw. den Zubehörteilen anderer Hersteller kann nicht gewährleistet werden. Stellen Sie des Weiteren VOR Montage dieses Produkts sicher, dass sich alle beweglichen Teile (z. B. die Kette) im ursprünglichen Wartungszustand befinden. Montiertes Zubehör kann das Fahrverhalten und/oder die Stabilität Ihres Fahrzeugs verändern.

ALLGEMEINE HINWEISE

Beachten Sie die landesspezifischen Vorschriften für Zulassung/Betrieb Ihres Fahrzeugs bzw. anwendbare TÜV-Vorschriften. Lassen Sie eintragungspflichtige Teile nach Montage durch Ihre Prüfstelle in die Fahrzeugpapiere eintragen.

VORBEREITUNG: Lesen Sie die Anbauanleitung aufmerksam und stellen Sie sicher, dass alle Teile der Stückliste vorhanden sind. Achten Sie darauf, dass Ihr Fahrzeug sicher steht und nicht umfallen kann. Schalten Sie den Motor ab und ziehen Sie den Zündschlüssel. Lassen Sie ggf. den Motor/Auspuff abkühlen. Klemmen Sie bei Arbeiten an der Elektrik die Fahrzeugbatterie ab. Verwenden Sie geeignetes Werkzeug. Lassen Sie sich von einer zweiten Person helfen.

MONTAGE: Alle vom Motorrad gelösten Teile und Verbindungen sind gemäß den Fahrzeugherstellereangaben wieder zu montieren oder durch die von SW-MOTECH gelieferten Teile zu ersetzen. Sichern Sie, falls nicht anderweitig definiert, alle Gewinde mit mittelfester, flüssiger Schraubensicherung.

Alle nicht durch SW-MOTECH definierten Anzugsmoment-Vorgaben müssen beim Fahrzeughersteller oder einer Fachwerkstatt erfragt werden!

FUNKTIONSKONTROLLE: Stellen Sie nach der Montage sicher, dass alle zuvor gelösten Teile und Verbindungen wieder ordnungsgemäß montiert wurden. Achten Sie außerdem auf die uneingeschränkte Freigängigkeit und einwandfreie Funktion sämtlicher Fahrzeugteile. Kabel, Züge und Schläuche dürfen nicht scheuern und/oder geklemmt werden. Führen Sie vor Fahrtbeginn eine umfassende Funktionskontrolle durch. Überprüfen Sie nach den ersten 50 km und anschließend in regelmäßigen Abständen das Anzugsmoment aller Schraubverbindungen und den ordnungsgemäßen Sitz des Produkts.

ENGLISH - Thank you for choosing this premium product from SW-MOTECH. Please visit our webshop for additional information, such as application charts and PDF mounting instructions. Any other documents that may be required (e.g. ABE certifications), are also available for download at our webshop.

Installation and/or maintenance of this product require good technical understanding! For your own safety SW-MOTECH recommends having installation and/or servicing carried out by a specialist workshop! SW-MOTECH assumes no liability for damage caused by improper installation and/or maintenance work!

Carefully follow all the directions given in the mounting instructions and pay attention to all relevant information in the vehicle manual during assembly. Nonconformance can lead to vehicle damage or even endanger the driver! These mounting instructions are written based on our current state of knowledge. Legal requirements for accuracy do not exist.

This product was developed for vehicles in their factory setting. Compatibility with original accessory parts or other manufacturers' accessory parts is not guaranteed. Furthermore, BEFORE installing this product, make sure that all moving parts (e.g. the chain) are in the original state of maintenance. Installed accessories can change the driving behaviour and/or stability of your vehicle.

GENERAL INFORMATION

Observe the country-specific regulations concerning vehicle registration/operation as well as TÜV regulations if applicable. If required, register installed parts in the vehicle documents through an appropriate inspection authority.

PREPARATION: Read the mounting instructions carefully and make sure that all items of the parts list are included. Make sure that your vehicle is parked safely and cannot fall over. Turn off the engine and remove the ignition key. Let the motor/exhaust cool off if necessary. Disconnect the vehicle battery when working on the electrical system. Use appropriate tools. Have another person to help you.

MOUNTING: All parts and connections removed from the vehicle must be reinstalled in accordance with the vehicle manufacturers' specifications or replaced by parts delivered by SW-MOTECH. Secure all threads, unless otherwise specified, with medium-strength liquid thread locker.

Torque specifications undefined by SW-MOTECH must be obtained from the vehicle manufacturer or by a specialist workshop!

FUNCTION CHECK: After installation make sure that all parts and connections previously removed are properly replaced. Also make sure that no moving parts are obstructed and no function of the vehicle is hindered in any way. Cables and hoses must not rub and/or be pinched. Before starting to ride, perform a comprehensive check of all functions. After the first 50 km and then at regular intervals, check the tightening torque of all screw connections and the proper fit of the product.

Konfektionierung durch / Packed by:

Datum der Konfektionierung / Date of packaging:

**SW-MOTECH GmbH & Co. KG**Ernteweg 8/10
35282 Rauschenberg
GermanyTel. / phone + 49 (0)6425 / 8168 - 050
Fax / fax + 49 (0)6425 / 8168 - 10**info@sw-motech.com**
www.sw-motech.com

ADVENTURE-RACK Gepäckträger
ADVENTURE RACK

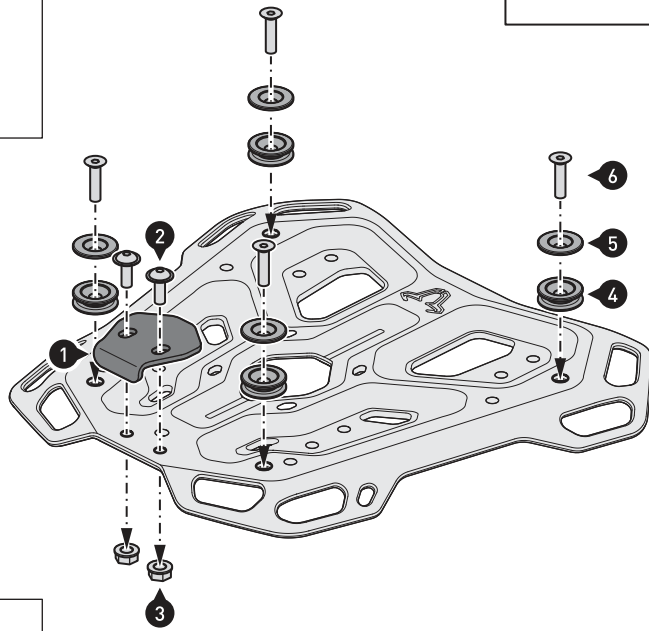
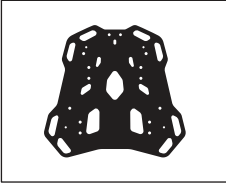

	9 N·m

ADVENTURE-RACK Gepäckträger
Verschrauben Sie die gezeigten Teile an ihrem ADVENTURE-RACK Gepäckträger (separat erhältlich).
ACHTUNG: Verwenden Sie flüssige Schraubensicherung (nur Schrauben (6))!
Ziehen Sie die Schrauben wie in der Stückliste vorgegeben an.

ACHTUNG: Um den sicheren Halt Ihres TRAX ADV/EVO/ION Topcase zu gewährleisten, justieren Sie den Vorspannwinkel (1) über die Langlöcher (siehe Detailzeichnung)! Achten Sie darauf, dass der Spannverschluss des Topcase bei Befestigung ordnungsgemäß greift!

ADVENTURE RACK

Attach the shown parts to your ADVENTURE RACK (sold separately).

ATTENTION: Use liquid thread locker (screws (6) only)!
Tighten the screws as specified in the parts list.

ATTENTION: To ensure the proper fit of your TRAX ADV/EVO/ION topcase, adjust the latch hook (1) over the elongated holes (see detail drawing)! Make sure that the topcase's latch engages properly when mounted!

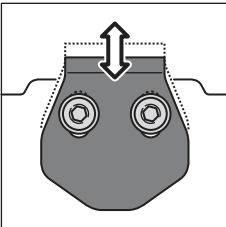

	7 N·m
	Medium

Adapterplatte für STREET-RACK
Adapter plate for STREET-RACK

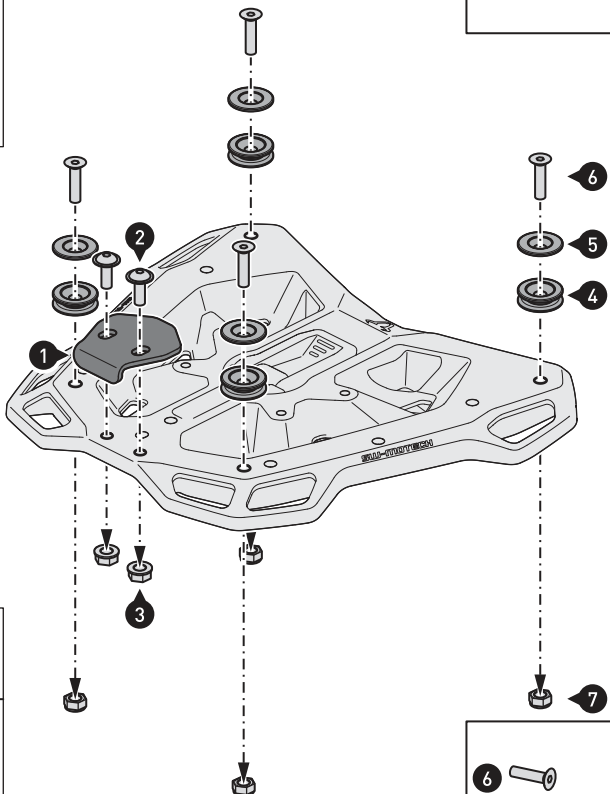
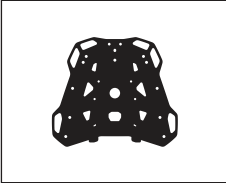

	9 N·m

Adapterplatte für STREET-RACK Gepäckträger

Verschrauben Sie die gezeigten Teile an ihrer Adapterplatte für STREET-RACK Gepäckträger (separat erhältlich).
Ziehen Sie die Schrauben wie in der Stückliste vorgegeben an.

ACHTUNG: Um den sicheren Halt Ihres TRAX ADV/EVO/ION Topcase zu gewährleisten, justieren Sie den Vorspannwinkel (1) über die Langlöcher (siehe Detailzeichnung)! Achten Sie darauf, dass der Spannverschluss des Topcase bei Befestigung ordnungsgemäß greift!

Adapter plate for STREET-RACK

Attach the shown parts to your adapter plate for STREET-RACK (sold separately).

Tighten the screws as specified in the parts list.

ATTENTION: To ensure the proper fit of your TRAX ADV/EVO/ION topcase, adjust the latch hook (1) over the elongated holes (see detail drawing)! Make sure that the topcase's latch engages properly when mounted!

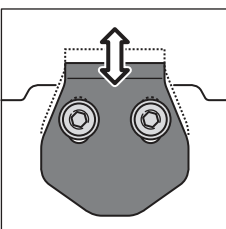

	7 N·m

TRAX ADVENTURE ALU-BOX

TRAX ADVENTURE ALU-BOX

DEUTSCH - Vielen Dank, dass Sie sich für dieses Qualitätsprodukt von SW-MOTECH entschieden haben.

☞ Bitte besuchen Sie unseren Webshop für weitere Informationen wie Modellzuweisungen und PDF-Anleitung. Erforderliche Dokumente (z. B. ABE) stehen als Download zur Verfügung. >> www.sw-motech.com

Die Montage und/oder Wartung dieses Produkts erfordert ein gutes technisches Verständnis. Zu Ihrer eigenen Sicherheit empfiehlt SW-MOTECH, die Montage und/oder Wartung durch eine Fachwerkstatt durchführen zu lassen. SW-MOTECH übernimmt keine Haftung für Schäden, die durch eine unsachgemäße Montage und/oder Wartung verursacht wurden.

Beachten Sie unbedingt alle in der Anbauanleitung angegebenen Hinweise. Beachten Sie außerdem alle für die Montage relevanten Hinweise im Fahrzeughandbuch. Nichtbeachtung kann zu Schäden am Fahrzeug bzw. zur Gefährdung des Fahrers führen! Bitte heben Sie die Anbauanleitung als Referenz auf.

Dieses Produkt wurde für Fahrzeuge im Originalzustand entwickelt. Die Kompatibilität mit originalen Zubehörteilen bzw. den Zubehörteilen anderer Hersteller kann nicht gewährleistet werden. Montiertes Zubehör kann das Fahrverhalten und/oder die Stabilität Ihres Fahrzeugs verändern.

ALLGEMEINE HINWEISE

Beachten Sie eventuelle landesspezifische Vorschriften durch den Gesetzgeber bzw. TÜV-Vorschriften. Lassen Sie eintragungspflichtige Teile nach Montage durch Ihre Prüfstelle in die Fahrzeugpapiere eintragen.

SICHERHEIT

Bitte beachten Sie unbedingt die folgenden Hinweise zur TRAX ADVENTURE ALU-BOX:

Die TRAX ADVENTURE ALU-BOX wurde ausschließlich für die Montage an SW-MOTECH QUICK-LOCK Kofferträgern, der QUICK-LOCK Adapterplatte und dem STEEL-RACK Adapterkit entwickelt.

Manipulation oder Veränderungen am Kofferaufbau führen zum Ausschluss jeglicher Gewährleistungen.

ACHTUNG: Das Fahr-/Bremsverhalten des Motorrads verändert sich bei montierter TRAX ADVENTURE ALU-BOX merklich.

ACHTUNG: Benutzen Sie die TRAX ADVENTURE ALU-BOXEN M & L nur paarweise. Achten Sie dabei auf die gleichmäßige Verteilung der Ladung.

ACHTUNG: Die vom Fahrzeughersteller definierte maximale Zuladung des Fahrzeugs darf NICHT überschritten werden!

Die maximal zulässige Zuladung des SW-MOTECH Gepäckträgers/Seitenträgers darf unter Berücksichtigung des Eigengewichts des Produkts NICHT überschritten werden!

ACHTUNG: Max. Zuladung: siehe Anbauanleitung vom SW-MOTECH Gepäckträger/Seitenträger.

Höchstgeschwindigkeit mit montierten Koffern: 130 km/h.

ACHTUNG: Stellen Sie sicher, dass die TRAX ADVENTURE ALU-BOX korrekt am jeweiligen Adapter befestigt wird und an allen vier Befestigungspunkten einrastet! ALLE Spannverschlüsse der TRAX ADVENTURE ALU-BOX müssen VOR Fahrtbeginn mit dem separat erhältlichen TraX ® EVO / TRAX ADV Schließzylinder-Satz verschlossen werden und während der Fahrt verschlossen bleiben. Bei unsachgemäßer Befestigung besteht Verlustgefahr!

PFLEGE

Verwenden Sie zum Reinigen der TRAX ADVENTURE ALU-BOX warme Seifenlauge und ein weiches, sauberes Tuch. Spülen Sie anschließend mit klarem Wasser nach. Verwenden Sie KEINE scharfen Reinigungsmittel, raue Putzutensilien oder einen Hochdruckreiniger!

ENGLISH - Thank you for choosing this premium product from SW-MOTECH.

☞ Please visit our webshop for additional information, such as application charts and PDF mounting instructions. Any other documents that may be required (e.g. ABE certifications), are also available for download at our webshop. >> www.sw-motech.com

Installation and/or maintenance of this product require good technical understanding. For your own safety SW-MOTECH recommends having installation and/or servicing carried out by a specialist workshop. SW-MOTECH assumes no liability for damage caused by improper installation and/or maintenance work.

Carefully follow all the directions given in the mounting instructions. Also pay attention to all relevant information in the vehicle manual during assembly. Nonconformance can lead to vehicle damage or even endanger the driver! Please keep the mounting instructions as reference.

This product was developed for vehicles in their original condition. Compatibility with original accessory parts or other manufacturers accessory parts is not guaranteed. Installed accessories can change driving behaviour and/or stability of your vehicle.

GENERAL INFORMATION

Observe any country-specific legal or TÜV regulations. If required, enter the installed parts into the vehicle documents with the appropriate inspection authority.

SECURITY

Please pay attention to the following information concerning the TRAX ADVENTURE ALU-BOX:

The TRAX ADVENTURE ALU-BOX is designed exclusively for mounting on SW-MOTECH QUICK-LOCK side carriers, QUICK-LOCK adapter plate and STEEL-RACK adapter kit.

Modifications made to the cases will void any warranty.

ATTENTION: Riding with TRAX ADVENTURE ALU-BOX may affect the motorcycle's driving and braking performance.

ATTENTION: TRAX ADVENTURE ALU-BOXES M & L must be used in pairs. Make sure the weight is evenly distributed between left and right side case.

DANGER: The maximum vehicle load defined by the vehicle manufacturer may NOT be exceeded.

The maximum permissible load of the SW-MOTECH luggage rack/side carrier may NOT be exceeded; make sure to take into account the dead weight of the product.

ATTENTION: Maximum load: Please refer to the mounting instructions of the SW-MOTECH luggage rack/side carrier. Maximum speed with mounted cases: 130 km/h (80 mph).

ATTENTION: Make sure that the TRAX ADVENTURE ALU-BOX is properly attached to the particular adapter and fully engaged to all four mounting points! ALL latches of the TRAX ADVENTURE ALU-BOX must be locked BEFORE riding with the TraX ® EVO / TRAX ADV lock cylinder set (sold separately) and remain closed while riding. Improperly mounted cases run the risk of detaching during transport.

CARE

To clean the TRAX ADVENTURE ALU-BOX, use warm, soapy water and a soft, clean cloth. Rinse with clean water. Do NOT use strong cleaning agents, rough cleaning tools or high pressure washer!



SW-MOTECH GmbH & Co. KG

Ernteweg 8/10
35282 Rauschenberg
Germany

Tel. / phone + 49 (0)6425 / 8168 - 050

Fax / fax + 49 (0)6425 / 8168 - 10

info@sw-motech.com
www.sw-motech.com

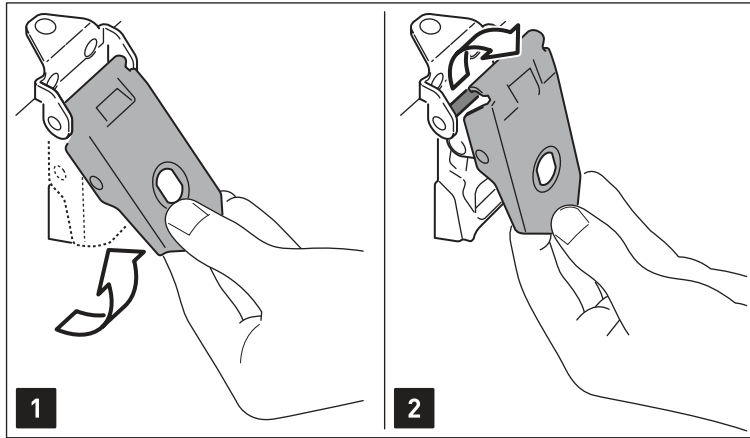

**Öffnen des Deckels
(TRAX ADV M / L / Topcase)**

- 1.- Ziehen Sie den Spannverschluss des Deckels nach oben ...
- 2.- ... und entfernen Sie diesen vom Spannverschlussbügel.
- 3.- Öffnen Sie anschließend den Deckel.

**Open the lid
(TRAX ADV M / L / topcase)**

- 1.- Pull the latch of the lid upwards ...
- 2.- ... and remove it from the latch bar.
- 3.- Open the lid.

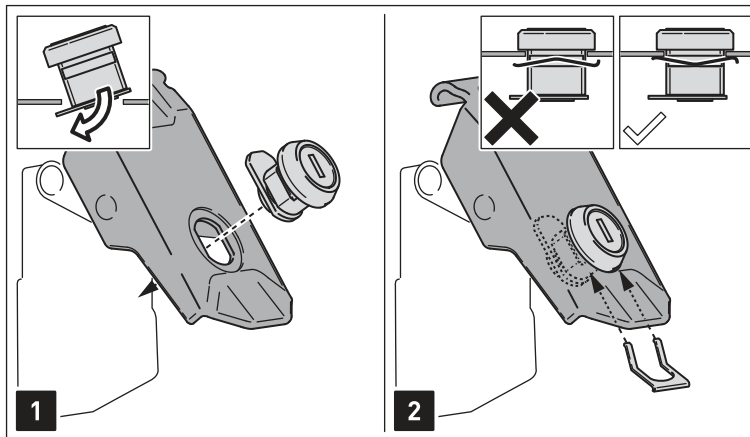

**Einsetzen des TraX® EVO / TRAX
ADV Schließzylinder-Satzes *
(TRAX ADV M / L / Topcase)**

- 1.- Setzen Sie die Schließzylinder in die Spannverschlüsse ein.
- 2.- Sichern Sie die Schließzylinder mit den Klemmblechen.
ACHTUNG: Achten Sie unbedingt auf die korrekte Ausrichtung der Klemmbleche (siehe Detailzeichnungen).
- 3.- Stecken Sie die Schlüssel in die Schließzylinder; öffnen bzw. schließen Sie die Schließzylinder, wie in der schematischen Zeichnung gezeigt.

**ACHTUNG: Zum Schmieren NUR
Grafitpulver verwenden!**

* separat erhältlich.

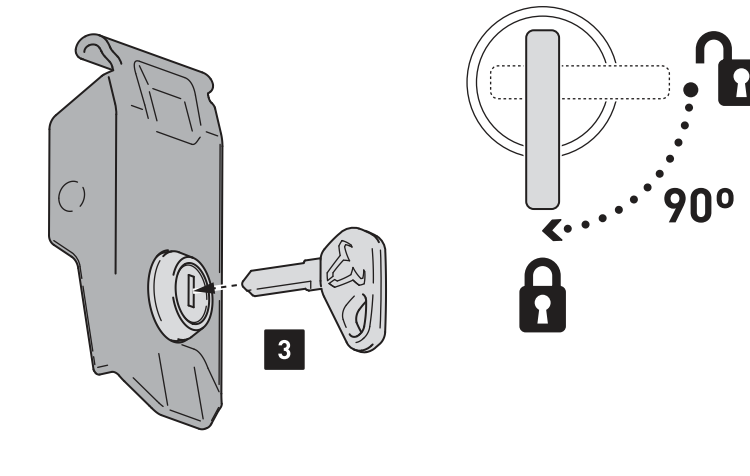

**Insertion of the TraX® EVO / TRAX
ADV lock cylinder set *
(TRAX ADV M / L / Topcase)**

- 1.- Insert the lock cylinders into the latches.
- 2.- Secure the lock cylinders with the clamping plates.
ATTENTION: Pay attention to the correct alignment of the clamping plates (as shown in the detail drawings).
- 3.- Insert the keys into the lock cylinders; open or close the lock cylinder as shown in the schematic drawing.

**ATTENTION: Use for lubrication
graphite powder ONLY!**

* Sold separately.

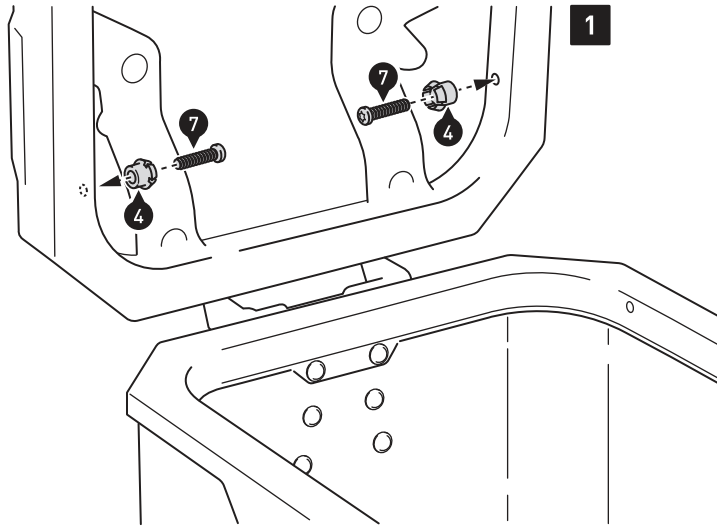
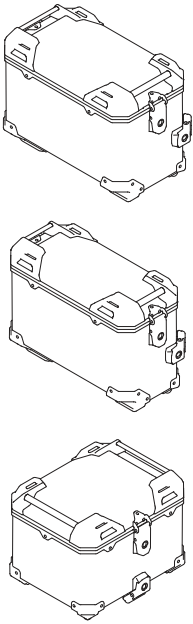

Montage der Deckelbegrenzer (TRAX ADV M / L / Topcase)

1.- Öffnen Sie den Deckel. Verschrauben Sie die Schnappverbindungen (4) mit den gezeigten Teilen am Deckelrahmen. Ziehen Sie die Schrauben wie in der Stückliste vorgegeben an.

2.- Verschrauben Sie die Deckelbegrenzer (5) mit den gezeigten Teilen am Korpusrahmen.

HINWEIS: Achten Sie auf die Links-Rechts-Spezifikation der Deckelbegrenzer (in Fahrtrichtung).

Ziehen Sie die Schrauben wie in der Stückliste vorgegeben an.

Drücken Sie die Deckelbegrenzer auf die Schnappverbindungen.

3.- Vor dem ersten Schließen müssen die Deckelbegrenzer ein wenig gestaucht werden, wie in der Zeichnung gezeigt.

Achten Sie beim Schließen des Deckels darauf, dass die Deckelbegrenzer nicht zwischen Deckel und Korpus geklemmt werden.

4.- Um den Deckel vom Korpus zu entfernen (siehe Seite 5), müssen zuvor die Deckelbegrenzer von den Schnappverbindungen gedrückt werden.

Mounting the lid limiters (TRAX ADV M / L / top case)

1.- Open the lid. Attach the snap-fit (4) with the shown parts at the lid frame. Tighten the screws as specified in the parts list.

2.- Attach the lid limiters (5) with the shown parts at the case frame.

NOTE: Pay attention to left-right specifications for the limiters (in driving direction).

Tighten the screws as specified in the parts list.

Press the lid limiters onto the snap-fits.

3.- Before closing the lid for the first time, the lid limiters must be compressed as shown in the drawing.

While closing the lid, make sure that the lid limiters are not pinched between lid and case.

4.- To remove the lid from the case (as shown on page 5), remove the lid limiters from the snap-fits first.

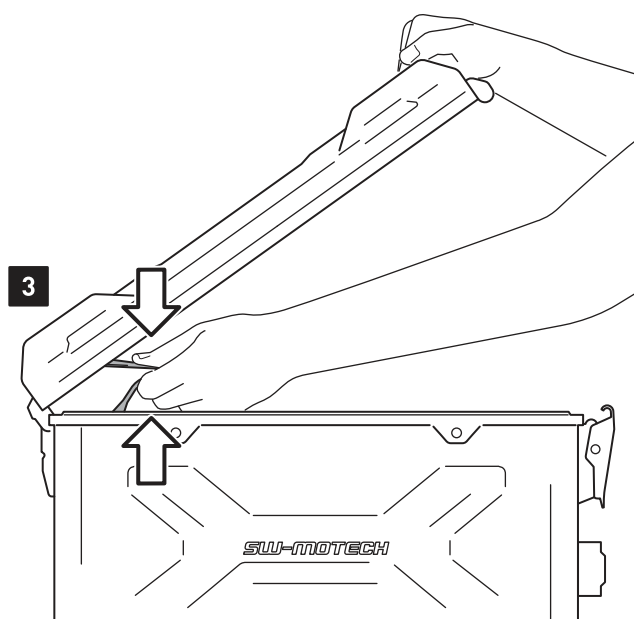
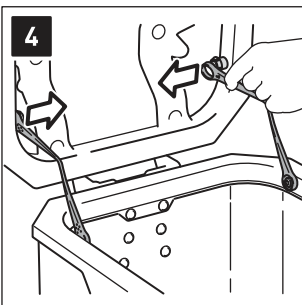
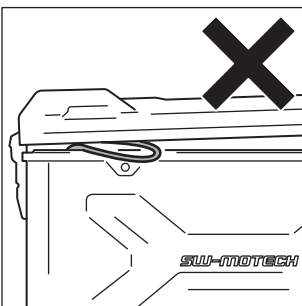
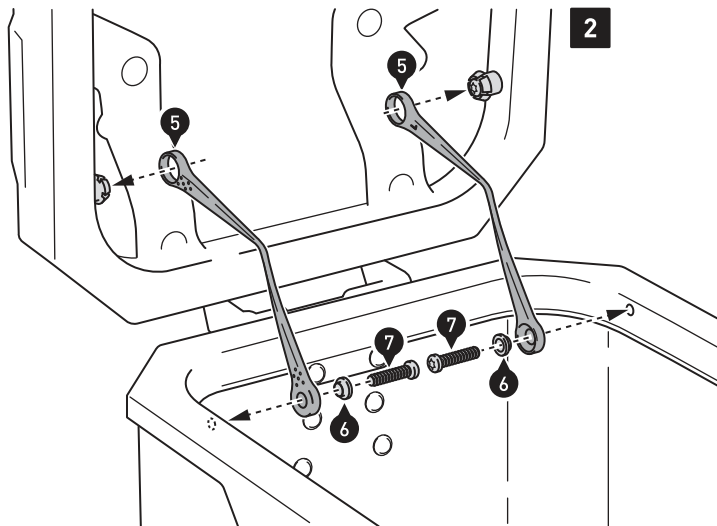
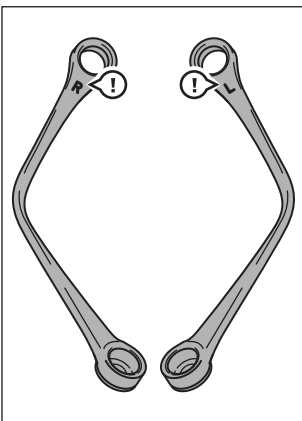

	<p>1</p> <p>2</p> <p>3</p>	<p>Entfernen des Deckels (TRAX ADVENTURE M / L)</p> <ol style="list-style-type: none"> 1.- Drücken Sie den Schnellverschluss nach unten, bis dieser einrastet und der Knopf heraus-springt. 2.- Anschließend kann der Deckel vom Korpus entfernt werden. <p><i>HINWEIS: Wenn Sie die Deckelbegrenzer (5) montiert haben, müssen diese vor Entfernen des Deckels gelöst werden (siehe Seite 4).</i></p> <ol style="list-style-type: none"> 3.- Um den wieder aufgesetzten Deckel zu verschließen, drücken Sie den Knopf des Schnellverschlusses. Achten Sie darauf, dass der Schnellverschluss oben einrastet. <p>Removing the lid (TRAX ADVENTURE M / L)</p> <ol style="list-style-type: none"> 1.- Press the quick release fastener down until it clicks into place and the button pops out. 2.- Then remove the lid from the case. <p><i>NOTE: If you have installed the lid limiters (5), they must be detached before removing the lid (as shown on page 4).</i></p> <ol style="list-style-type: none"> 3.- Press the button of the quick release fastener to lock the replaced lid in place. Make sure that the quick release fastener snaps above.
--	---	--

<p>1</p>	<p>3</p>	<p>Wartung und Reinigung des Schnellverschlusses (TRAX ADVENTURE M / L)</p> <ol style="list-style-type: none"> 1.- Lösen Sie die innenseitig verbauten Schrauben und entfernen Sie den Schnellverschluss vom Korpus. 2.- Lösen Sie die Schraube des Knopfes (mit Daumen und Zeigefinger fixieren). 3.- Lösen Sie vorsichtig den gezeigten Clip und ... 4.- ... entfernen Sie Schnellverschluss und Federn vom Halteblech. 5.- Reinigen Sie die Komponenten mit klarem Wasser und lassen Sie diese anschließend an der Luft trocknen. Verbauen Sie die Komponenten nun in umgekehrter Reihenfolge am Korpus.
<p>2</p>	<p>4</p> <p>5</p>	<p>Maintenance and cleaning of the quick release fastener (TRAX ADVENTURE M / L)</p> <ol style="list-style-type: none"> 1.- Loosen the six screws on the inner side of the case and remove the quick release fastener. 2.- Loosen the screw of the button (fix with thumb and index finger). 3.- Loosen the shown clip carefully and ... 4.- ... remove the quick release fastener and springs from the mounting plate. 5.- Clean the components with clean water and let it air dry. Reattach all parts in reversed order.

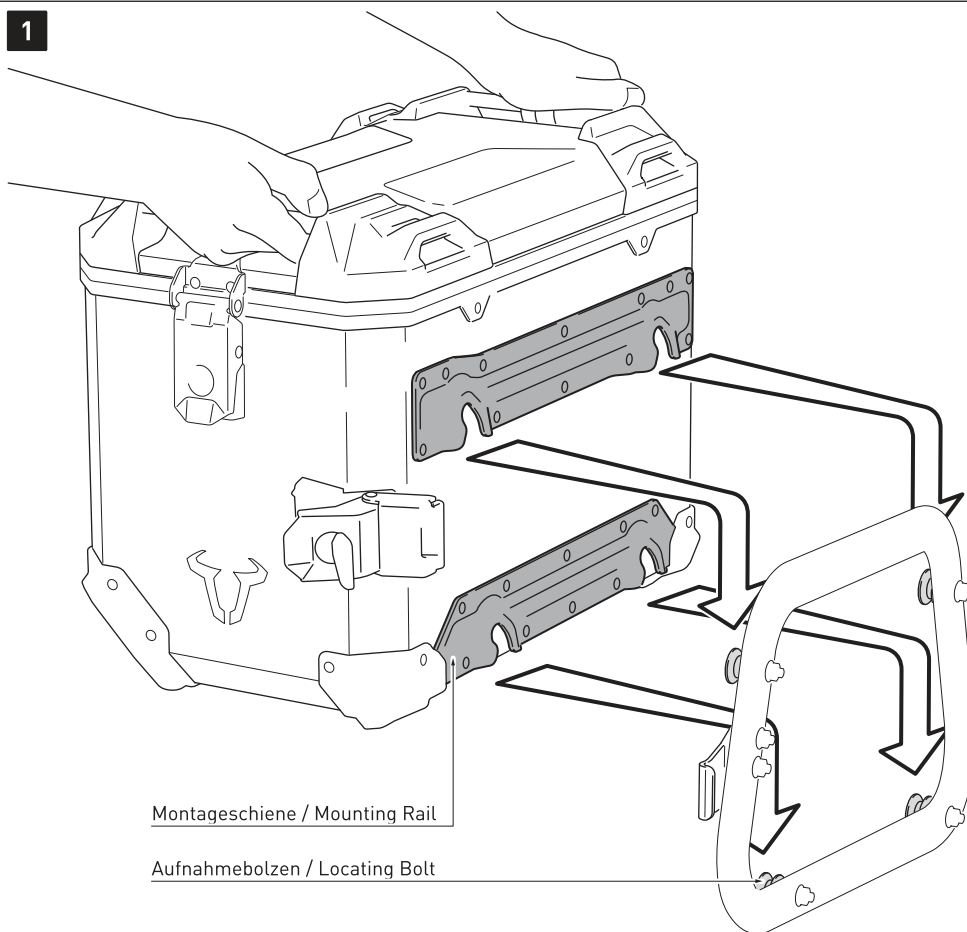

Montageschiene / Mounting Rail

Aufnahmebolzen / Locating Bolt



Befestigung der TRAX ADVENTURE ALU-BOX M & L

- 1.- Führen Sie die vier Öffnungen der Montageschienen über die Aufnahmebolzen des montierten QUICK-LOCK Adapterkits.
Drücken Sie anschließend die TRAX ADVENTURE ALU-BOX leicht nach unten, bis diese fest am QUICK-LOCK Kofferträger sitzt.
ACHTUNG: Achten Sie darauf, dass alle vier Aufnahmebolzen gleichzeitig einrasten.
 - 2.- Legen Sie den seitlichen Spannverschluss über den Vorspannwinkel und ...
 - 3.- ... klappen Sie den Spannverschluss um; überprüfen Sie den festen Sitz der TRAX ADVENTURE ALU-BOX am QUICK-LOCK Kofferträger.
- ACHTUNG: Achten Sie darauf, dass der Spannverschluss unter ausreichend Spannung steht! Andernfalls muss der Vorspannwinkel nachjustiert werden!**
- ACHTUNG: Sichern Sie die TRAX ADVENTURE ALU-BOX vor Fahrtbeginn mit dem separat erhältlichen TraX® EVO / TRAX ADVENTURE Schließzylinder-Satz am QUICK-LOCK Kofferträger!**

Attachement of TRAX ADVENTURE ALU-BOX M & L

- 1.- Lead the four openings of the mounting rails onto the locating bolts of the mounted QUICK-LOCK adapter kit.
Then press the TRAX ADVENTURE ALU-BOX slightly downward, until it properly rests on QUICK-LOCK side carrier.
ATTENTION: Make sure that all four locating bolts rests on at the same time.
 - 2.- Place the latch over the latch hook and ...
 - 3.- ... close the latch; check the proper fit of the TRAX ADVENTURE ALU-BOX on the QUICK-LOCK side carrier.
ATTENTION: Make sure the closed latch is under sufficient tension! If not the latch hook must be readjusted!
- ATTENTION: Secure the TRAX ADVENTURE ALU-BOX with the separately available TraX® EVO / TRAX ADVENTURE lock cylinder set at the QUICK-LOCK side carrier before riding!**

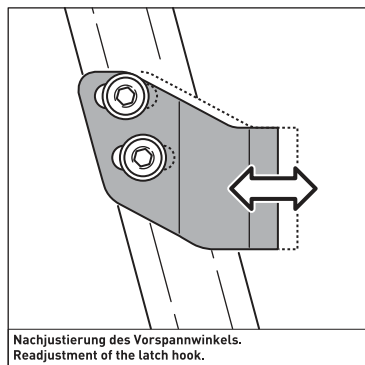
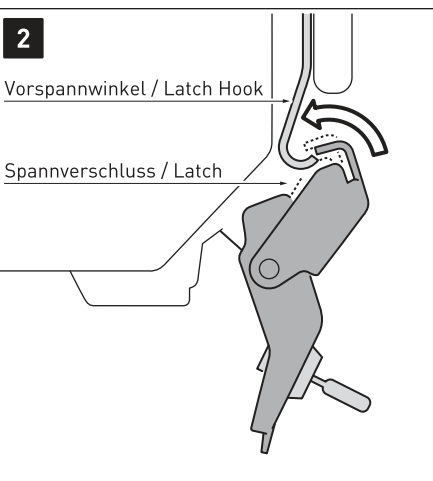
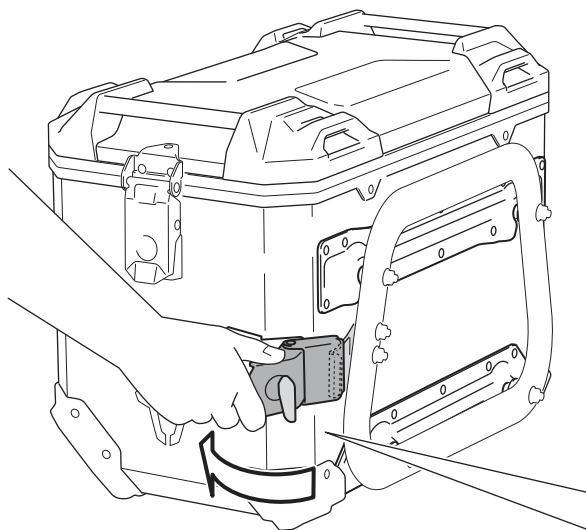

Nachjustierung des Vorspannwinkels.
Readjustment of the latch hook.

1

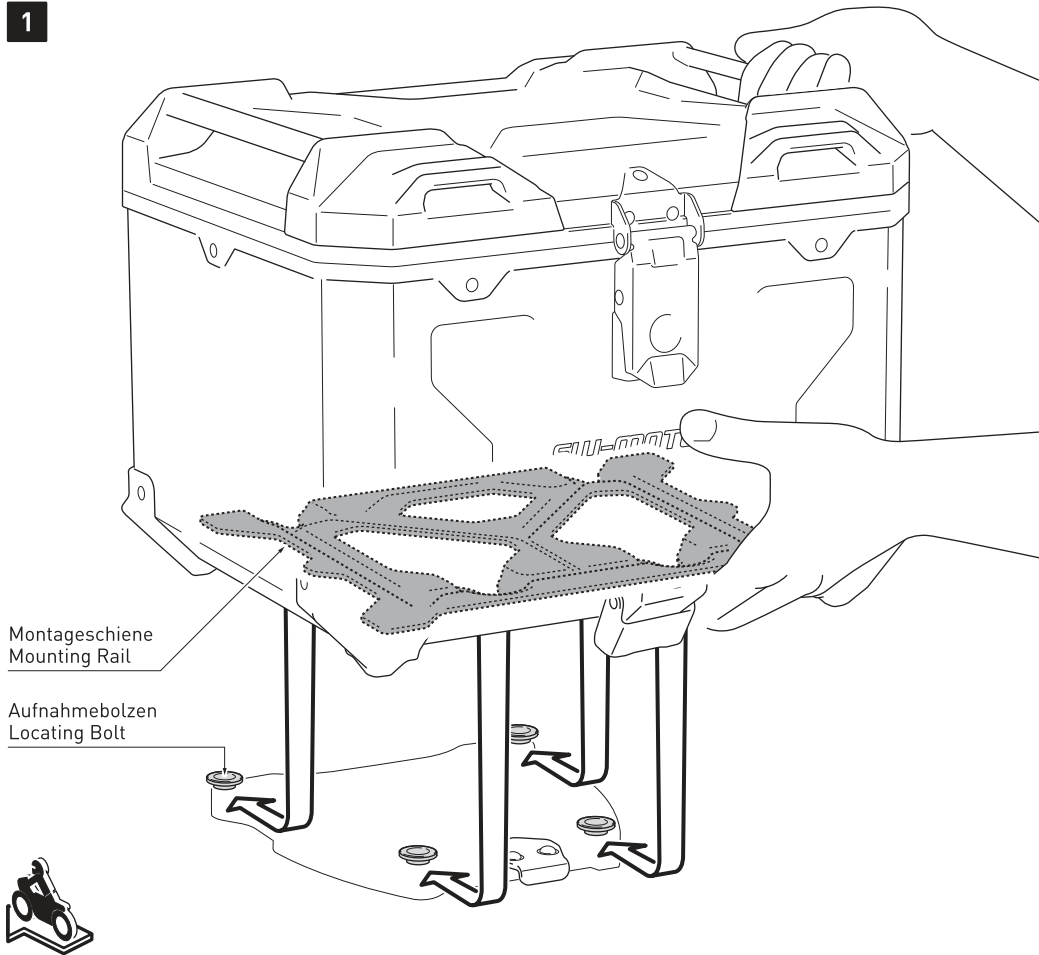

Befestigung der TRAX ADVENTURE ALU-BOX TC

1.- Führen Sie die vier Öffnungen der Montageschiene über die Aufnahmebolzen der montierten QUICK-LOCK Adapterplatte / STEEL-RACK Adapterkit.

Drücken Sie anschließend die TRAX ADVENTURE ALU-BOX leicht nach vorne, bis diese fest auf der QUICK-LOCK Adapterplatte / STEEL-RACK Adapterkit sitzt.

ACHTUNG: Achten Sie darauf, dass alle vier Aufnahmebolzen gleichzeitig einrasten.

2.- Führen Sie den unteren Spannverschluss über den Vorspannwinkel und ...

3.- ... klappen Sie den Spannverschluss um; überprüfen Sie den festen Sitz der TRAX ADVENTURE ALU-BOX auf der QUICK-LOCK Adapterplatte / STEEL-RACK Adapterkit.

ACHTUNG: Achten Sie darauf, dass der Spannverschluss unter ausreichend Spannung steht! Andernfalls muss der Vorspannwinkel nachjustiert werden!

ACHTUNG: Sichern Sie die TRAX ADVENTURE ALU-BOX vor Fahrtbeginn mit dem separat erhältlichen TraX® EVO / TRAX ADVENTURE Schließzylinder-Satz an der QUICK-LOCK Adapterplatte / STEEL-RACK Adapterkit!

Attachement of TRAX ADVENTURE ALU-BOX M & L

1.- Lead the four openings of the mounting rail onto the locating bolts of the mounted QUICK-LOCK adapter plate / STEEL-RACK adapter kit.

Then press the TRAX ADVENTURE ALU-BOX slightly forward, until it properly rests on QUICK-LOCK adapter plate / STEEL-RACK adapter kit.

ATTENTION: Make sure that all four locating bolts rests on at the same time.

2.- Place the latch over the latch hook and ...

3.- ... close the latch; check the proper fit of the TRAX ADVENTURE ALU-BOX on the QUICK-LOCK Adapter Plate / STEEL-RACK Adapter Kit.

ATTENTION: Make sure the closed latch is under sufficient tension! If not the latch hook must be readjusted!

ATTENTION: Secure the TRAX ADVENTURE ALU-BOX with the separately available TraX® EVO / TRAX ADVENTURE lock cylinder set at the QUICK-LOCK adapter plate / STEEL-RACK adapter kit before riding!

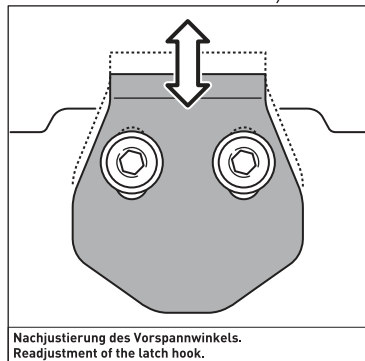
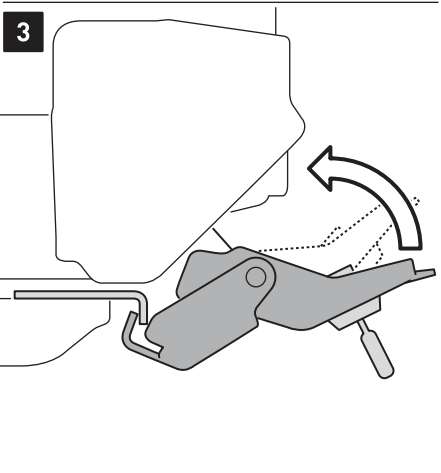
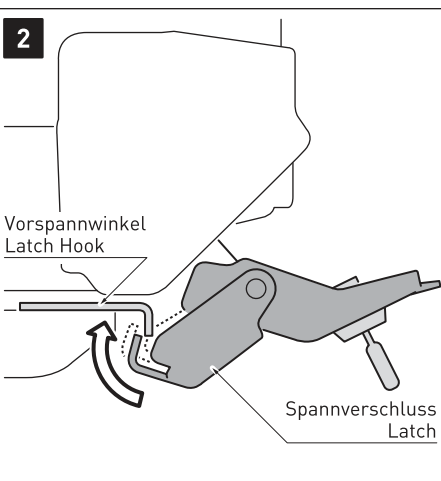

TRAX ADV

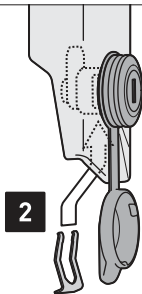
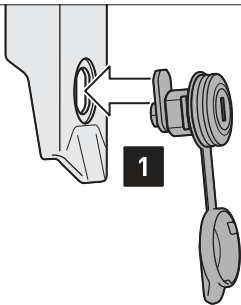

TRAX ION

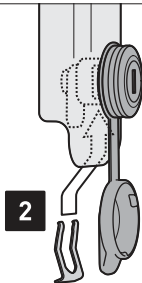
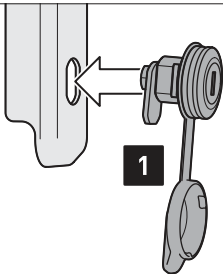

Revision: 00 - 05 - 2020

