

ANBAUANLEITUNG

mounting instructions • instructions de montage • instrucciones de montaje • istruzioni di montaggio

HDG.00.220.20500/B

beinhaltet • contains • contient • contiene • contiene

HDG.00.220.80501/B

HDG.00.220.10300/B

Item number: HDG.00.220.80501/B

Revision: 00 · Date: 01 - 2024

Handguard mounting kit

 ~ 0.5 h.

EASY  DIFFICULT

ENGLISH Thank you for choosing this premium product from SW-MOTECH. Visit our online shop for more information (e.g. model assignments). Required documents (e.g. national type approval) are available there for you to download.

Please read and understand all the instructions, safety information and warnings in these mounting instructions before mounting and using the product in order to avoid injury and damage. Keep these mounting instructions for reference.

This product was developed for vehicles in factory condition. Compatibility with original accessories or accessories from other manufacturers cannot be guaranteed.

These mounting instructions have been prepared to the best of our current knowledge. No legal claims relating to accuracy can be made. Errors and omissions excepted. We reserve the right to make technical and design changes. The copyright is held by SW-MOTECH.

SAFETY WARNING SYMBOL

 This warning symbol is used in these mounting instructions to warn of deadly dangers, injuries or other hazards. The words DANGER, WARNING or CAUTION are used as part of this warning symbol to convey important safety messages and information relating to the installation and use of this product. These words, together with the safety warning symbol, mean:

 **DANGER:** Indicates a hazardous situation which, if not avoided, will result in death or serious injury!

 **WARNING:** Indicates a hazardous situation which, if not avoided, may result in death or serious injury!

 **CAUTION:** Indicates a hazardous situation which, if not avoided, may result in minor or moderate injury!

 **NOTE:** Important information, but not relating to a risk of death or injury (property damage only)!

GENERAL INFORMATION

 **WARNING:** Assembly and/or maintenance of this product requires advanced technical skill, appropriate tools, and a good understanding of tool usage and torque specifications. For your own safety, SW-MOTECH recommends having the assembly and/or maintenance carried out by a qualified and certified motorcycle workshop.

 **WARNING:** If you do choose to assemble this product yourself, carefully and fully read the mounting instructions before assembly and use, and follow all instructions to avoid serious injury or death. Also observe all relevant information in the vehicle manual when mounting or using the product. IF YOU DO NOT UNDERSTAND ANY PART OF THESE MOUNTING INSTRUCTIONS OR NEED AN EXPLANATION AS TO A SPECIFIC INSTRUCTION, DO NOT ATTEMPT TO INSTALL THIS PRODUCT WITHOUT CONSULTING SW-MOTECH FOR ASSISTANCE!

PREPARATION: Read the mounting instructions carefully and make sure that all parts on the parts list are available.

 **CAUTION:** Ensure that your vehicle is standing securely. Switch off the engine and remove the ignition key. Allow the engine/exhaust to cool down if necessary. Disconnect the battery when working on the electrical system. Only use proper tools and always wear safety goggles and gloves during assembly and maintenance. Have a second person help you with assembly and maintenance.

ASSEMBLY: All parts and connections removed from the vehicle must be reinstalled according to the vehicle manufacturer's specifications or replaced with parts and hardware supplied by SW-MOTECH.

 **WARNING:** Secure all threads with a medium-strength liquid threadlocker, unless otherwise specified.

 **DANGER:** Tightening torques not defined by SW-MOTECH must be obtained from the vehicle manufacturer or a certified motorbike workshop.

FUNCTIONAL CHECK: After mounting the product, ensure that no moving parts are obstructed and that the function of the vehicle is not impeded. Cables and hoses must not rub against each other and/or be hindered in any way.

 **WARNING:** Carry out a comprehensive functionality check before you start to drive. Check the tightening torque of all connections and the tight fit of the product after the first 50 km and then at regular intervals. Mounted accessories can change the handling and stability of the vehicle.



SW-MOTECH GmbH & Co. KG
Ernteweg 7-10
35282 Rauschenberg
Germany



info@sw-motech.com
www.sw-motech.com



Take note of the symbols and what they mean in the ASSEMBLY section. If the term OEM appears in the ASSEMBLY section, the vehicle manufacturer's specifications must be observed and applied.



If you have any questions, please don't hesitate to contact our Customer Service team or our distributors. You can find our telephone number and a list of our distributors in our online shop:

www.sw-motech.com



Use thread locker: Indicates that a thread must be coated with liquid thread locker. H (HIGH): high strength; M (MEDIUM): medium strength; L (LOW): low strength.



Tighten/note the tightening torque information:

Indicates the tightening torque of a part specified by SW-MOTECH or the vehicle manufacturer (OEM).



Do not use thread lock: Indicates that no liquid thread lock should be used at this point.

PARTS LIST - READ AND KEEP MOUNTING INSTRUCTIONS!

1

1



HDG.00.220.906.01.25

 2/2

2



HDG.07.904.001L.25

 1/1

3



HDG.07.904.001R.25

 1/1

4



M6 x 20; DIN 7380
SC.ST.06.020.02.7380.109

 2/2

2

5



HDG.00.220.025L.25

 1/1

6



HDG.00.220.025R.25

 1/1

7



M10 x 55; DIN 6912
SC.ST.10.055.02.6912.088

 2/2

8



HDG.00.220.010.25

 2/2

9



Ø 20 / ø 10,5 / h 10
DB.00.200.105.010.01

 2/2

3

10



M6 x 22; DIN 7991
SC.ST.06.022.48.7991.088

 2/2

11



ø 6.4; DIN 9021
US.ST.064.02.9021

 2/2

12



M6; DIN 6927
MU.ST.06.02.6927.08

 2/2

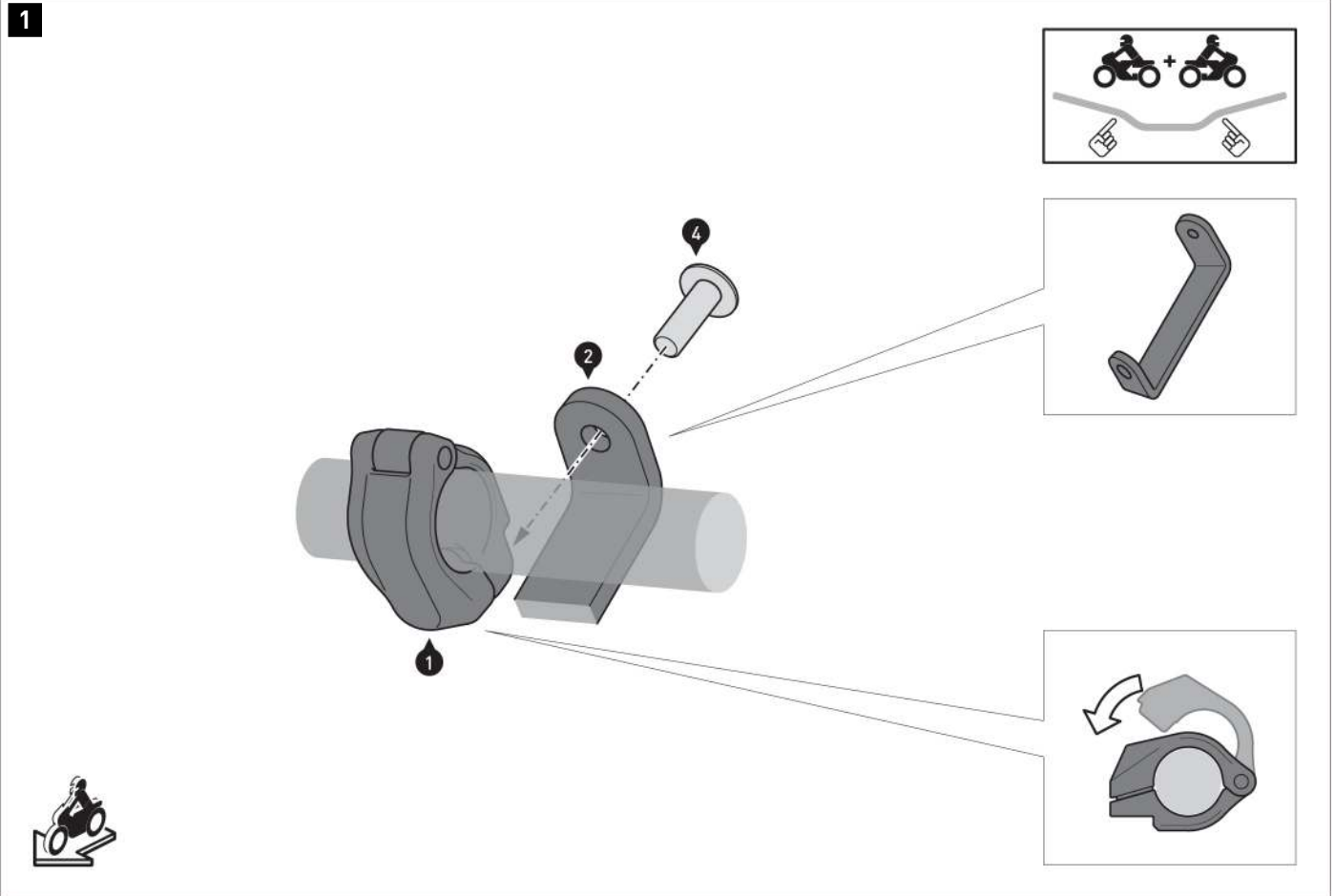

⚠ WARNING: Since the handguard mounting kit is installed in a safety-relevant area of the vehicle, SW-MOTECH recommends having the installation/maintenance of the product carried out by a qualified specialist workshop.

⚠ WARNING: Always wear eye and hand protection!
⚠ WARNING: Always use the proper tools!

⚠ NOTE: Installation is shown on the left side. Repeat the installation with the corresponding parts on the right side of the handlebar.

⚠ NOTE: The handlebar shown serves as an example.

⚠ NOTE: The connecting plate (2/3) shown in the drawing is for illustrative purposes only. The correct image and orientation of the connecting plate are shown in the detailed drawing on the right.

Place the clamps (1) around the handlebars at the locations shown in the detailed drawing above.

Screw the connecting plates (2/3) to the clamps (1) LOOSELY. The clamps (1) must remain movable for positioning.

⚠ WARNING: Use a liquid threadlocker!
 Tighten the screws (4) hand-tight.



M 8 Nm

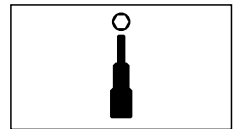
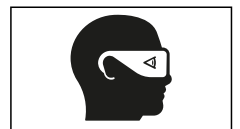

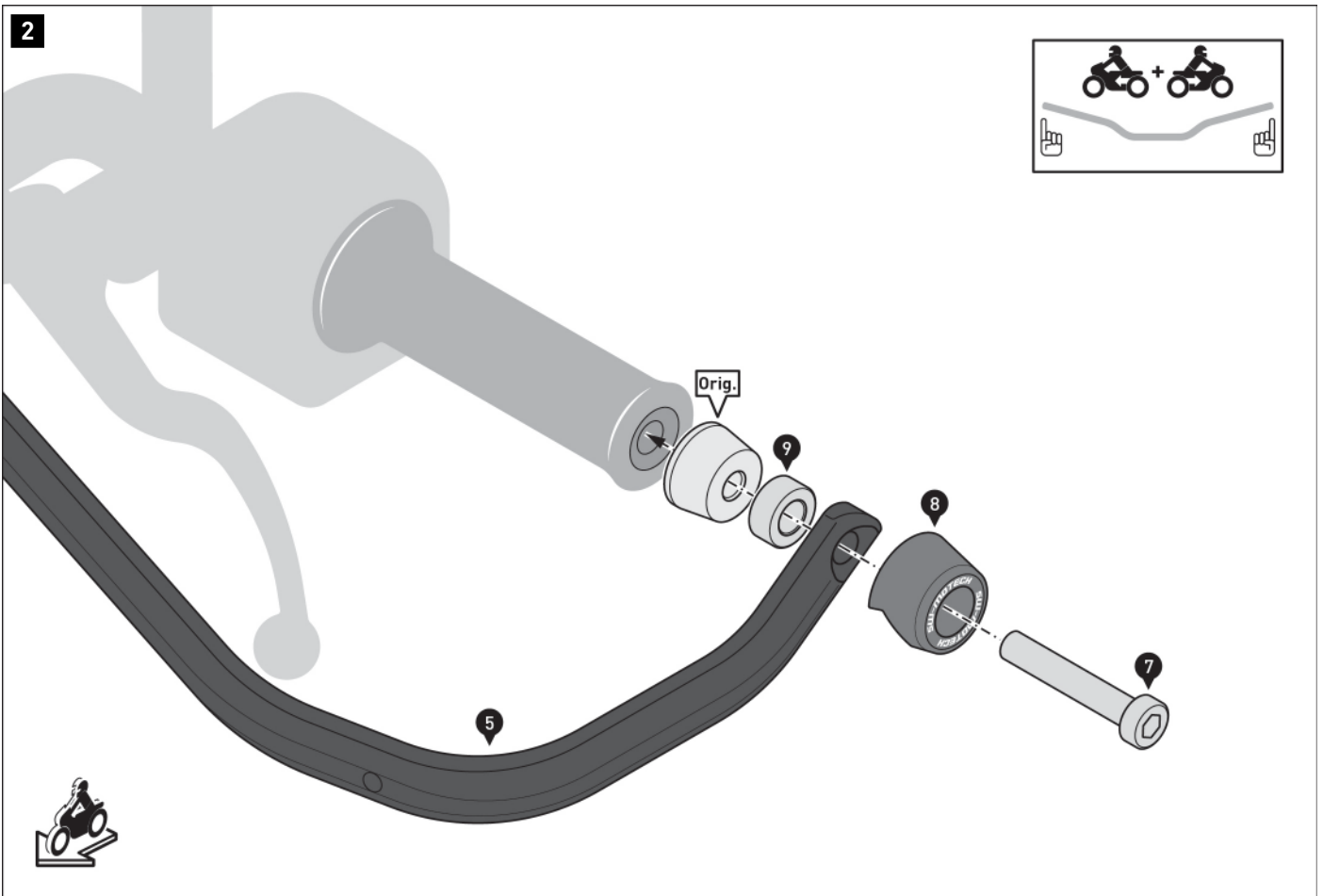

Remove the original end weights and handguards if mounted.
Make sure the handlebar ends and the inside of the handlebars are clear.

Loosely screw the parts indicated with the brackets (5/6) on to the handlebar ends.

⚠ WARNING: Use a liquid threadlocker!

To do so, tighten the screw (7) so that the brackets (5/6) can still be readjusted.

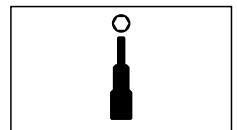
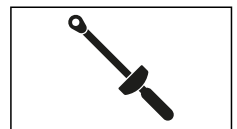

3

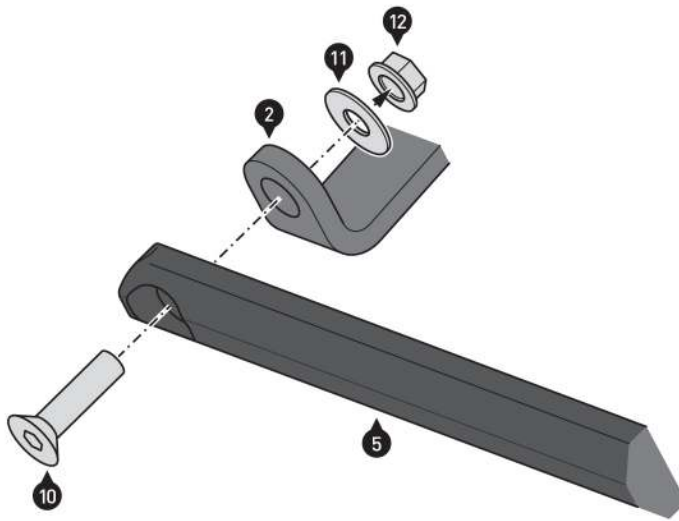

Screw the inner ends of the brackets (5/6) to the connecting plates (2/3). Do not tighten the screws (10) yet.

Now position the brackets (5/6) according to your personal preferences and tighten all screws in the following order and as specified in the mounting instructions: (10), (4), (7).

▲ DANGER: If there is not enough space after installation of all components, the brake and clutch unit must be moved a few millimeters towards the end or middle of the handlebar!

▲ DANGER: After installation, make sure that all switch and control units, especially the throttle assembly, brake lever, emergency stop switch and clutch, function properly and are easy to use! Also make sure that the handlebars can be fully turned in both directions. If parts of the product come into contact with the tank or other vehicle components when the steering wheel is at full lock, repositioning the product or the handlebars is absolutely necessary! Make sure that the installation complies with the vehicle manufacturer's specifications! DO NOT ride your vehicle if the switch and control units are not functioning correctly or cannot be operated correctly! BEFORE every ride, carry out a complete functional check of the handlebars and all fittings!

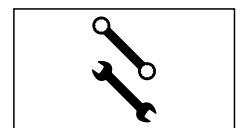
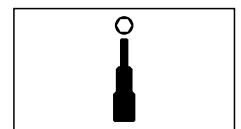
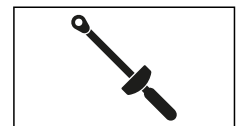

PRODUCT-SPECIFIC NOTES

⚠ NOTE: *Observe the country-specific regulations for the registration/operation of your vehicle or applicable TÜV regulations. After assembly, have parts that are subject to registration entered in the vehicle documents by your test centre.*

Item number: HDG.00.220.10300/B

Revision: 01 · Date: 12 - 2023

Sport handguard shell set

 ~ 0.25 h.EASY      DIFFICULT

ENGLISH Thank you for choosing this premium product from SW-MOTECH. Visit our online shop for more information (e.g. model assignments). Required documents (e.g. national type approval) are available there for you to download.

Please read and understand all the instructions, safety information and warnings in these mounting instructions before mounting and using the product in order to avoid injury and damage. Keep these mounting instructions for reference.

This product was developed for vehicles in factory condition. Compatibility with original accessories or accessories from other manufacturers cannot be guaranteed.

These mounting instructions have been prepared to the best of our current knowledge. No legal claims relating to accuracy can be made. Errors and omissions excepted. We reserve the right to make technical and design changes. The copyright is held by SW-MOTECH.

SAFETY WARNING SYMBOL

 This warning symbol is used in these mounting instructions to warn of deadly dangers, injuries or other hazards. The words DANGER, WARNING or CAUTION are used as part of this warning symbol to convey important safety messages and information relating to the installation and use of this product. These words, together with the safety warning symbol, mean:

 **DANGER:** Indicates a hazardous situation which, if not avoided, will result in death or serious injury!

 **WARNING:** Indicates a hazardous situation which, if not avoided, may result in death or serious injury!

 **CAUTION:** Indicates a hazardous situation which, if not avoided, may result in minor or moderate injury!

 **NOTE:** Important information, but not relating to a risk of death or injury (property damage only)!

GENERAL INFORMATION

 **WARNING:** Assembly and/or maintenance of this product requires advanced technical skill, appropriate tools, and a good understanding of tool usage and torque specifications. For your own safety, SW-MOTECH recommends having the assembly and/or maintenance carried out by a qualified and certified motorcycle workshop.

 **WARNING:** If you do choose to assemble this product yourself, carefully and fully read the mounting instructions before assembly and use, and follow all instructions to avoid serious injury or death. Also observe all relevant information in the vehicle manual when mounting or using the product. IF YOU DO NOT UNDERSTAND ANY PART OF THESE MOUNTING INSTRUCTIONS OR NEED AN EXPLANATION AS TO A SPECIFIC INSTRUCTION, DO NOT ATTEMPT TO INSTALL THIS PRODUCT WITHOUT CONSULTING SW-MOTECH FOR ASSISTANCE!

PREPARATION: Read the mounting instructions carefully and make sure that all parts on the parts list are available.

 **CAUTION:** Ensure that your vehicle is standing securely. Switch off the engine and remove the ignition key. Allow the engine/exhaust to cool down if necessary. Disconnect the battery when working on the electrical system. Only use proper tools and always wear safety goggles and gloves during assembly and maintenance. Have a second person help you with assembly and maintenance.

ASSEMBLY: All parts and connections removed from the vehicle must be reinstalled according to the vehicle manufacturer's specifications or replaced with parts and hardware supplied by SW-MOTECH.

 **WARNING:** Secure all threads with a medium-strength liquid threadlocker, unless otherwise specified.

 **DANGER:** Tightening torques not defined by SW-MOTECH must be obtained from the vehicle manufacturer or a certified motorbike workshop.



FUNCTIONAL CHECK: After mounting the product, ensure that no moving parts are obstructed and that the function of the vehicle is not impeded. Cables and hoses must not rub against each other and/or be hindered in any way.

 **WARNING:** Carry out a comprehensive functionality check before you start to drive. Check the tightening torque of all connections and the tight fit of the product after the first 50 km and then at regular intervals. Mounted accessories can change the handling and stability of the vehicle.



SW-MOTECH GmbH & Co. KG
Ernteweg 7-10
35282 Rauschenberg
Germany



 info@sw-motech.com
 www.sw-motech.com

LEGEND OVERVIEW - READ AND KEEP MOUNTING INSTRUCTIONS!



Take note of the symbols and what they mean in the ASSEMBLY section. If the term OEM appears in the ASSEMBLY section, the vehicle manufacturer's specifications must be observed and applied.



If you have any questions, please don't hesitate to contact our Customer Service team or our distributors. You can find our telephone number and a list of our distributors in our online shop:

www.sw-motech.com



Do not use thread lock: Indicates that no liquid thread lock should be used at this point.



Tighten by hand: Indicates that the attachment must be carefully tightened by hand.

PARTS LIST - READ AND KEEP MOUNTING INSTRUCTIONS!

1

1



HDG.00.220.004L.02

 **1/1**

2



HDG.00.220.004R.02

 **1/1**

3



HDG.00.220.006.02

 **4/4**

4



M3,5 x 12
SC.ST.035.012.02

 **8/8**

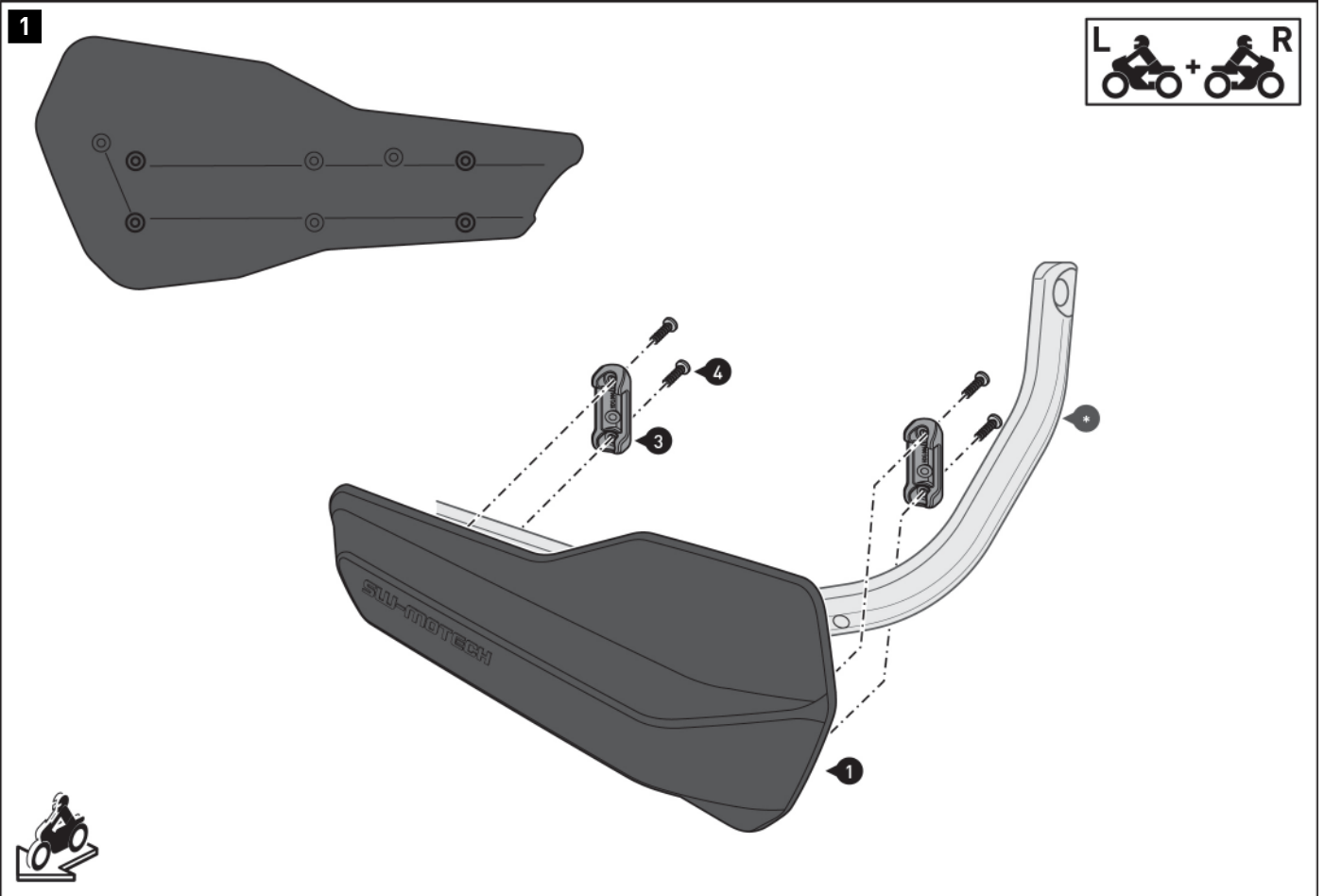

▲ WARNING: Always wear eye and hand protection!
▲ WARNING: Always use the proper tools!

△ NOTE: Installation is shown on the left side. Repeat the installation with the corresponding parts on the right side of the handlebar.

Screw the sports hand-guard shells (1/2) onto the brackets (*). Carefully tighten the screws (4) hand-tight (max. 1 Nm).

▲ WARNING: Tightening too tightly can damage the plastic parts!

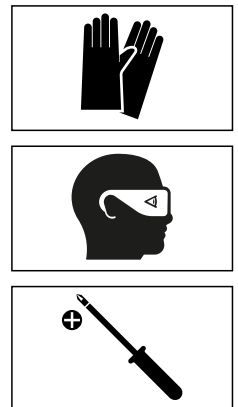

PRODUCT-SPECIFIC NOTES

⚠ NOTE: *Observe the country-specific regulations for the registration/operation of your vehicle or applicable TÜV regulations. After assembly, have parts that are subject to registration entered in the vehicle documents by your test centre.*