

ANBAUANLEITUNG

mounting instructions • instructions de montage • instrucciones de montaje • istruzioni di montaggio

GPT.07.573.65000/B

beinhaltet • contains • contient • contiene • contiene

GPT.07.573.16000/B

GPT.00.152.54900/B

HSK.00.745.11000/B

LOC.00.745.10100

Art.-Nr. / Item No.: **GPT.07.573.16000/B**

Revision: **01** · Datum / Date: **09 - 2020**

STREET-RACK Gepäckträger

STREET-RACK

DEUTSCH - Vielen Dank, dass Sie sich für dieses Premium-Produkt von SW-MOTECH entschieden haben. Bitte besuchen Sie unseren Webshop für weitere Informationen wie Modellzuweisungen und PDF-Anbauanleitung. Erforderliche Dokumente (z. B. ABE) stehen als Download zur Verfügung.

Die Montage und/oder Wartung dieses Produkts erfordert ein gutes technisches Verständnis! Zu Ihrer eigenen Sicherheit empfiehlt SW-MOTECH, die Montage und/oder Wartung durch eine Fachwerkstatt durchführen zu lassen! SW-MOTECH übernimmt keine Haftung für Schäden, die durch eine unsachgemäße Montage und/oder Wartung verursacht wurden!

Beachten Sie alle in der Anbauanleitung angegebenen Hinweise und die für die Montage relevanten Informationen im Fahrzeughandbuch. Nichtbeachtung kann zu Schäden am Fahrzeug bzw. zur Gefährdung des Fahrers führen! Diese Anbauanleitung ist nach unserem derzeitigen Kenntnisstand verfasst worden. Rechtliche Ansprüche auf Richtigkeit bestehen nicht.

Dieses Produkt wurde für Fahrzeuge im Werkzustand entwickelt. Die Kompatibilität mit Original-Zubehörteilen bzw. den Zubehörteilen anderer Hersteller kann nicht gewährleistet werden. Stellen Sie des Weiteren VOR Montage dieses Produkts sicher, dass sich alle beweglichen Teile (z. B. die Kette) im ursprünglichen Wartungszustand befinden. Montiertes Zubehör kann das Fahrverhalten und/oder die Stabilität Ihres Fahrzeugs verändern.

ALLGEMEINE HINWEISE

Beachten Sie die landesspezifischen Vorschriften für Zulassung/Betrieb Ihres Fahrzeugs bzw. anwendbare TÜV-Vorschriften. Lassen Sie eintragungspflichtige Teile nach Montage durch Ihre Prüfstelle in die Fahrzeugpapiere eintragen.

VORBEREITUNG: Lesen Sie die Anbauanleitung aufmerksam und stellen Sie sicher, dass alle Teile der Stückliste vorhanden sind. Achten Sie darauf, dass Ihr Fahrzeug sicher steht und nicht umfallen kann. Schalten Sie den Motor ab und ziehen Sie den Zündschlüssel. Lassen Sie ggf. den Motor/Auspuff abkühlen. Klemmen Sie bei Arbeiten an der Elektrik die Fahrzeugbatterie ab. Verwenden Sie geeignetes Werkzeug. Lassen Sie sich von einer zweiten Person helfen.

MONTAGE: Alle vom Motorrad gelösten Teile und Verbindungen sind gemäß den Fahrzeugherstellereangaben wieder zu montieren oder durch die von SW-MOTECH gelieferten Teile zu ersetzen. Sichern Sie, falls nicht anderweitig definiert, alle Gewinde mit mittelfester, flüssiger Schraubensicherung.

Alle nicht durch SW-MOTECH definierten Anzugsmoment-Vorgaben müssen beim Fahrzeughersteller oder einer Fachwerkstatt erfragt werden!

FUNKTIONSKONTROLLE: Stellen Sie nach der Montage sicher, dass alle zuvor gelösten Teile und Verbindungen wieder ordnungsgemäß montiert wurden. Achten Sie außerdem auf die uneingeschränkte Freigängigkeit und einwandfreie Funktion sämtlicher Fahrzeugteile. Kabel, Züge und Schläuche dürfen nicht scheuern und/oder geklemmt werden. Führen Sie vor Fahrtbeginn eine umfassende Funktionskontrolle durch. Überprüfen Sie nach den ersten 50 km und anschließend in regelmäßigen Abständen das Anzugsmoment aller Schraubverbindungen und den ordnungsgemäßen Sitz des Produkts.

PRODUKTSPEZIFISCHE HINWEISE

Maximale Zuladung	Höchstgeschwindigkeit
 7,5 KG (16,5 lbs)	 130 km/h (80 mph)

ACHTUNG: Die angegebene maximale Zuladung beinhaltet das Gewicht von Koffer/Gepäck und Adapterplatte! Es gilt die vom Fahrzeughersteller genannte, maximale Zuladung des Fahrzeugs!

ENGLISH - Thank you for choosing this premium product from SW-MOTECH. Please visit our webshop for additional information, such as application charts and PDF mounting instructions. Any other documents that may be required (e.g. ABE certifications), are also available for download at our webshop.

Installation and/or maintenance of this product require good technical understanding! For your own safety SW-MOTECH recommends having installation and/or servicing carried out by a specialist workshop! SW-MOTECH assumes no liability for damage caused by improper installation and/or maintenance work!

Carefully follow all the directions given in the mounting instructions and pay attention to all relevant information in the vehicle manual during assembly. Nonconformance can lead to vehicle damage or even endanger the driver! These mounting instructions are written based on our current state of knowledge. Legal requirements for accuracy do not exist.

This product was developed for vehicles in their factory setting. Compatibility with original accessory parts or other manufacturers' accessory parts is not guaranteed. Furthermore, BEFORE installing this product, make sure that all moving parts (e.g. the chain) are in the original state of maintenance. Installed accessories can change the driving behaviour and/or stability of your vehicle.

GENERAL INFORMATION

Observe the country-specific regulations concerning vehicle registration/operation as well as TÜV regulations if applicable. If required, register installed parts in the vehicle documents through an appropriate inspection authority.

PREPARATION: Read the mounting instructions carefully and make sure that all items of the parts list are included. Make sure that your vehicle is parked safely and cannot fall over. Turn off the engine and remove the ignition key. Let the motor/exhaust cool off if necessary. Disconnect the vehicle battery when working on the electrical system. Use appropriate tools. Have another person to help you.

MOUNTING: All parts and connections removed from the vehicle must be reinstalled in accordance with the vehicle manufacturers' specifications or replaced by parts delivered by SW-MOTECH. Secure all threads, unless otherwise specified, with medium-strength liquid thread locker.

Torque specifications undefined by SW-MOTECH must be obtained from the vehicle manufacturer or by a specialist workshop!

FUNCTION CHECK: After installation make sure that all parts and connections previously removed are properly replaced. Also make sure that no moving parts are obstructed and no function of the vehicle is hindered in any way. Cables and hoses must not rub and/or be pinched. Before starting to ride, perform a comprehensive check of all functions. After the first 50 km and then at regular intervals, check the tightening torque of all screw connections and the proper fit of the product.

PRODUCT SPECIFIC INFORMATION

Maximum Load	Maximum Speed
 7.5 KG (16.5 lbs)	 130 km/h (80 mph)

ATTENTION: The indicated maximum load is inclusive the weight of topcase/luggage and adapter plate! The maximum vehicle load specified by the manufacturer must not be exceeded!

Konfektionierung durch / Packed by:

Datum der Konfektionierung / Date of packaging:



SW-MOTECH GmbH & Co. KG
Ernteweg 8/10
35282 Rauschenberg
Germany

Tel. / phone + 49 (0)6425 / 8168 - 050
Fax / fax + 49 (0)6425 / 8168 - 10
info@sw-motech.com
www.sw-motech.com

STÜCKLISTE / PARTS LIST

Schritt Step	Nr. No.	Art.-Nr. / Bezeichnung * Item No. / Description *	Artikel	Part	Anzahl ** Quantity **	N-m ***	
1	(1)	GPT.00.573.050	Gepäckträger	Luggage Rack	1 / 1		
	(2)	GPT.07.573.001L / R	Anbaublech; links / rechts	Mounting Bracket; left / right	2 / 2		
	(3)	M8 x 20; DIN 7991	Senkkopfschraube; schwarz	Countersung Screw; black	4 / 4	20	
	(4)	ø 8,4	Senkscheibe; schwarz	Countersunk Washer; black	4 / 4		
2	(5)	M8 x 70; DIN 912	Innensechskantschraube; schwarz	Hexagon Socket Screw; black	2 / 2	20	
	(6)	ø 8,4; DIN 125	Unterlegscheibe; schwarz	Washer; black	2 / 6		
	(7)	Ø 20 / ø 8,4 / h 43	Distanzbuchse	Spacer	2 / 2		
	(8)	M8 x 20; DIN 6912	Innensechskantschraube, fl. Kopf; schwarz	Hexagon Socket Screw, short head; black	2 / 2	20	
	(9)	ø 8,4; DIN 125	Unterlegscheibe; schwarz	Washer; black	2 / 6		
	(10)	M8 x 45; DIN 912	Innensechskantschraube	Hexagon Socket Screw	2 / 2	20	
	(11)	ø 8,4; DIN 125	Unterlegscheibe; schwarz	Washer; black	2 / 6		
	(12)	Ø 16 / ø 8,4 / h 32	Distanzbuchse	Spacer	2 / 2		

8.8	Regelgewinde / Coarse Thread Ø							10.9	Regelgewinde / Coarse Thread Ø						
	M4	M5	M6	M8	M10	M12	M4		M5	M6	M8	M10	M12		
	Stahl FK 8.8 / Steel CL 8.8								Stahl FK 10.9 / Steel CL 10.9						
	N·m								N·m						
	2,8	5,5	9,6	23	46	79		4,1	8,1	14	34	67	115		

* Alle Maßangaben in Millimeter. - ** Der zweite Wert gibt die Gesamtanzahl des jew. Artikels in der Lieferung an.
 *** **Keine Anzugsmomentvorgabe: Verwenden Sie das vom Fzg.-Hersteller definierte Anzugsmoment!** Das Standard-Anzugsmoment der Tabelle kann verwendet werden, wenn es den Fzg.-Hersteller-Vorgaben entspricht.

* All measurements in millimeters. - ** The second number indicates the total quantity of the part in the delivery.
 *** **No torque specifications: Use the torque defined by vehicle manufacturer!** The standard torque in this table can be used as long as it is within the vehicle manufacturer's specifications.

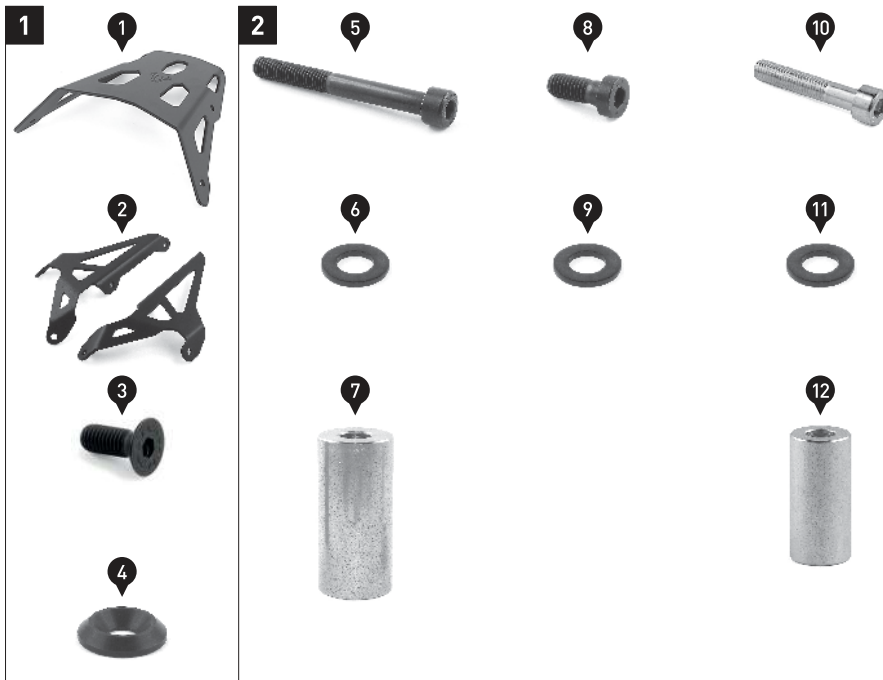

MONTAGE / MOUNTING

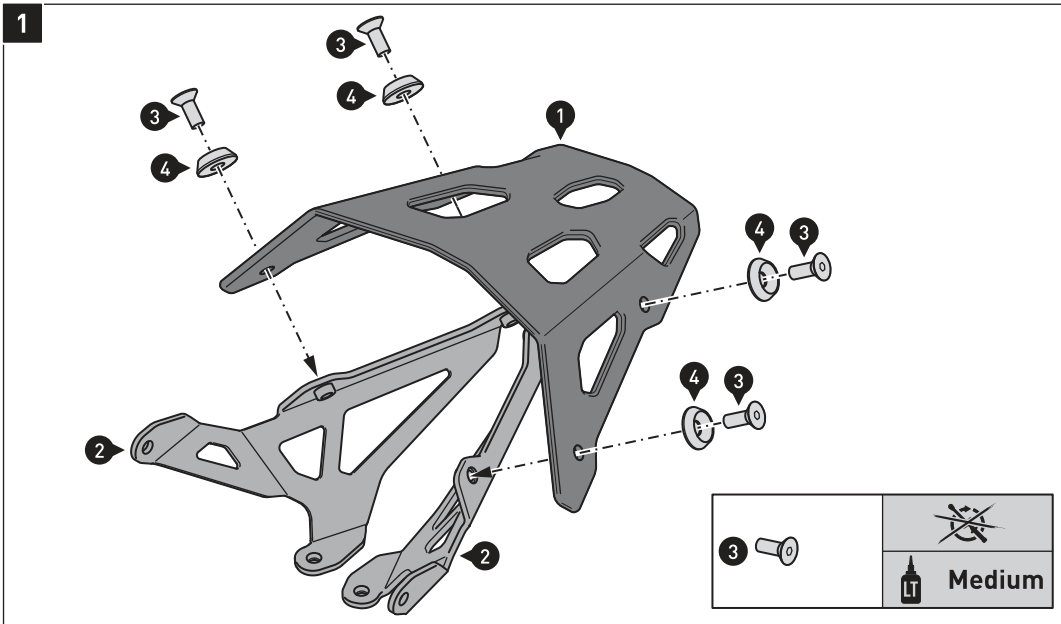

Verschrauben Sie die Anbaubleche (2) mit dem Gepäckträger (1), wie in der Zeichnung gezeigt.
ACHTUNG: Verwenden Sie flüssige Schraubensicherung!
 Ziehen Sie die Schrauben noch nicht an.

Attach the mounting brackets (2) with the luggage rack (1), as shown in the drawing.
ATTENTION: Use liquid thread locker!
 Do not fully tighten the screws yet.

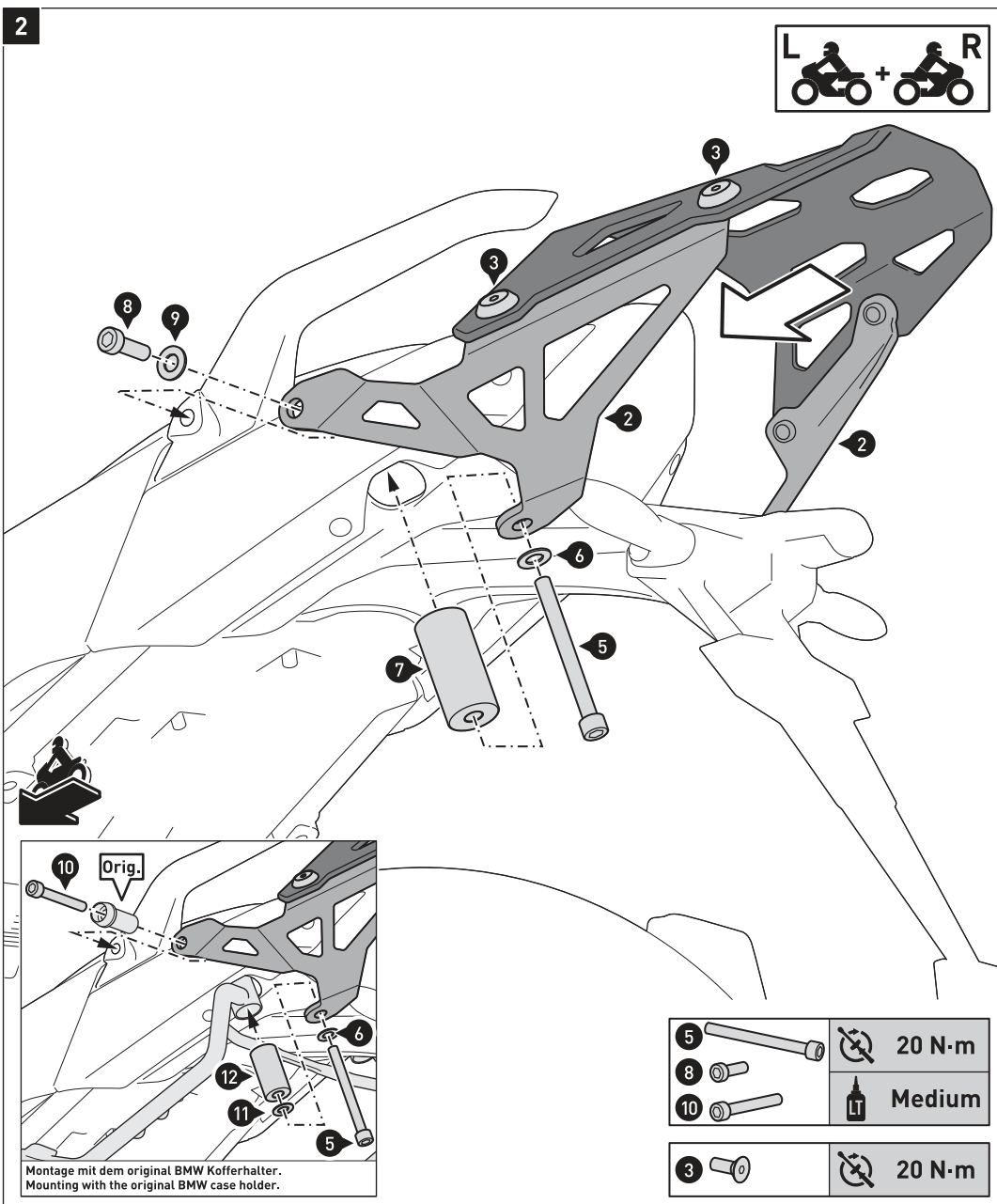

Verschrauben Sie die Anbaubleche (2) am Fahrzeug, wie in der Zeichnung gezeigt.
HINWEIS: Beachten Sie die in der Detailzeichnung gezeigte Verbausituation mit dem original BMW Kofferhalter.

Verwenden Sie anstelle der Distanzbuchsen (7) die Distanzbuchsen (12) und Unterlegscheiben (11) wie gezeigt.

Montieren Sie die Haltepilze (Orig.) mit den Schrauben (10) am Fahrzeug.
ACHTUNG: Verwenden Sie flüssige Schraubensicherung!

Wenn alle Komponenten spannungsfrei sitzen, ziehen Sie die Schrauben wie vorgegeben an.

Attach the mounting brackets (2) to the vehicle, as shown in the drawing.

NOTE: Pay attention to the mounting situation with the original BMW case holder, shown in the detail drawing. Use the spacers (12) instead of spacers (7) and the washers (11) as shown.

Attach the mushroom bolts (Orig.) with the screws (10) to the vehicle.

ATTENTION: Use liquid thread locker!

Once all the parts are evenly positioned without excess tension, tighten the screws as specified.

Item number: GPT.00.152.54900/B

Revision: 00 · Date: 08 - 2023

Adapter plate for STREET-RACK

 ~ 0.25 h.EASY      DIFFICULT

ENGLISH Thank you for choosing this premium product from SW-MOTECH. Visit our online shop for more information (e.g. model assignments). Required documents (e.g. national type approval) are available there for you to download.

Please read and understand all the instructions, safety information and warnings in these mounting instructions before mounting and using the product in order to avoid injury and damage. Keep these mounting instructions for reference.

This product was developed for vehicles in factory condition. Compatibility with original accessories or accessories from other manufacturers cannot be guaranteed.

These mounting instructions have been prepared to the best of our current knowledge. No legal claims relating to accuracy can be made. Errors and omissions excepted. We reserve the right to make technical and design changes. The copyright is held by SW-MOTECH.

SAFETY WARNING SYMBOL

 This warning symbol is used in these mounting instructions to warn of deadly dangers, injuries or other hazards. The words DANGER, WARNING or CAUTION are used as part of this warning symbol to convey important safety messages and information relating to the installation and use of this product. These words, together with the safety warning symbol, mean:

 **DANGER:** Indicates a hazardous situation which, if not avoided, will result in death or serious injury!

 **WARNING:** Indicates a hazardous situation which, if not avoided, may result in death or serious injury!

 **CAUTION:** Indicates a hazardous situation which, if not avoided, may result in minor or moderate injury!

 **NOTE:** Important information, but not relating to a risk of death or injury (property damage only)!

GENERAL INFORMATION

 **WARNING:** Assembly and/or maintenance of this product requires advanced technical skill, appropriate tools, and a good understanding of tool usage and torque specifications. For your own safety, SW-MOTECH recommends having the assembly and/or maintenance carried out by a qualified and certified motorcycle workshop.

 **WARNING:** If you do choose to assemble this product yourself, carefully and fully read the mounting instructions before assembly and use, and follow all instructions to avoid serious injury or death. Also observe all relevant information in the vehicle manual when mounting or using the product. IF YOU DO NOT UNDERSTAND ANY PART OF THESE MOUNTING INSTRUCTIONS OR NEED AN EXPLANATION AS TO A SPECIFIC INSTRUCTION, DO NOT ATTEMPT TO INSTALL THIS PRODUCT WITHOUT CONSULTING SW-MOTECH FOR ASSISTANCE!

PREPARATION: Read the mounting instructions carefully and make sure that all parts on the parts list are available.

 **CAUTION:** Ensure that your vehicle is standing securely. Switch off the engine and remove the ignition key. Allow the engine/exhaust to cool down if necessary. Disconnect the battery when working on the electrical system. Only use proper tools and always wear safety goggles and gloves during assembly and maintenance. Have a second person help you with assembly and maintenance.

ASSEMBLY: All parts and connections removed from the vehicle must be reinstalled according to the vehicle manufacturer's specifications or replaced with parts and hardware supplied by SW-MOTECH.

 **WARNING:** Secure all threads with a medium-strength liquid threadlocker, unless otherwise specified.

 **DANGER:** Tightening torques not defined by SW-MOTECH must be obtained from the vehicle manufacturer or a certified motorbike workshop.



FUNCTIONAL CHECK: After mounting the product, ensure that no moving parts are obstructed and that the function of the vehicle is not impeded. Cables and hoses must not rub against each other and/or be hindered in any way.

 **WARNING:** Carry out a comprehensive functionality check before you start to drive. Check the tightening torque of all connections and the tight fit of the product after the first 50 km and then at regular intervals. Mounted accessories can change the handling and stability of the vehicle.



SW-MOTECH GmbH & Co. KG
Ernteweg 7-10
35282 Rauschenberg
Germany



 info@sw-motech.com
 www.sw-motech.com



Take note of the symbols and what they mean in the ASSEMBLY section. If the term OEM appears in the ASSEMBLY section, the vehicle manufacturer's specifications must be observed and applied.



If you have any questions, please don't hesitate to contact our Customer Service team or our distributors. You can find our telephone number and a list of our distributors in our online shop:

www.sw-motech.com



Use thread locker: Indicates that a thread must be coated with liquid thread locker. H (HIGH): high strength; M (MEDIUM): medium strength; L (LOW): low strength.



Tighten/note the tightening torque information:

Indicates the tightening torque of a part specified by SW-MOTECH or the vehicle manufacturer (OEM).

PARTS LIST - READ AND KEEP MOUNTING INSTRUCTIONS!

1

1



GPT.00.152.502.01.02

 1/1

2



HSK.00.745.025.356R

 1/1

3



M6 x 14; ISO 7380
SC.ST.06.014.02.7380.109

 2/2

4



GPT.00.152.035.02

 4/4

5



GPT.00.152.010.35

 2/2

6



M6 x 25; DIN 7991
SC.ST.06.025.02.7991.088

 2/2

7



M6; DIN 985
MU.A4.06.01.985.70

 2/2

1

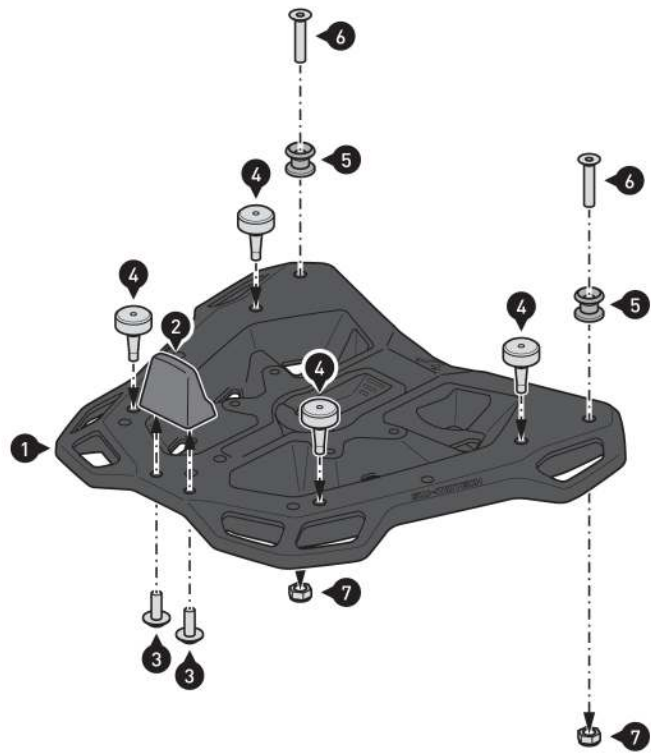

▲ WARNING: Always wear eye and hand protection!
▲ WARNING: Always use the proper tools!

Screw the parts indicated to the adapter plate (1).

▲ WARNING: Use liquid thread locker (NOT on the screws (6))!
 Tighten the screws as specified in the mounting instructions.

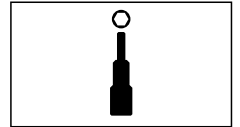
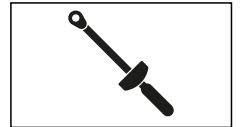
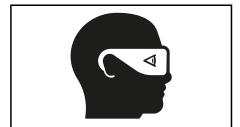

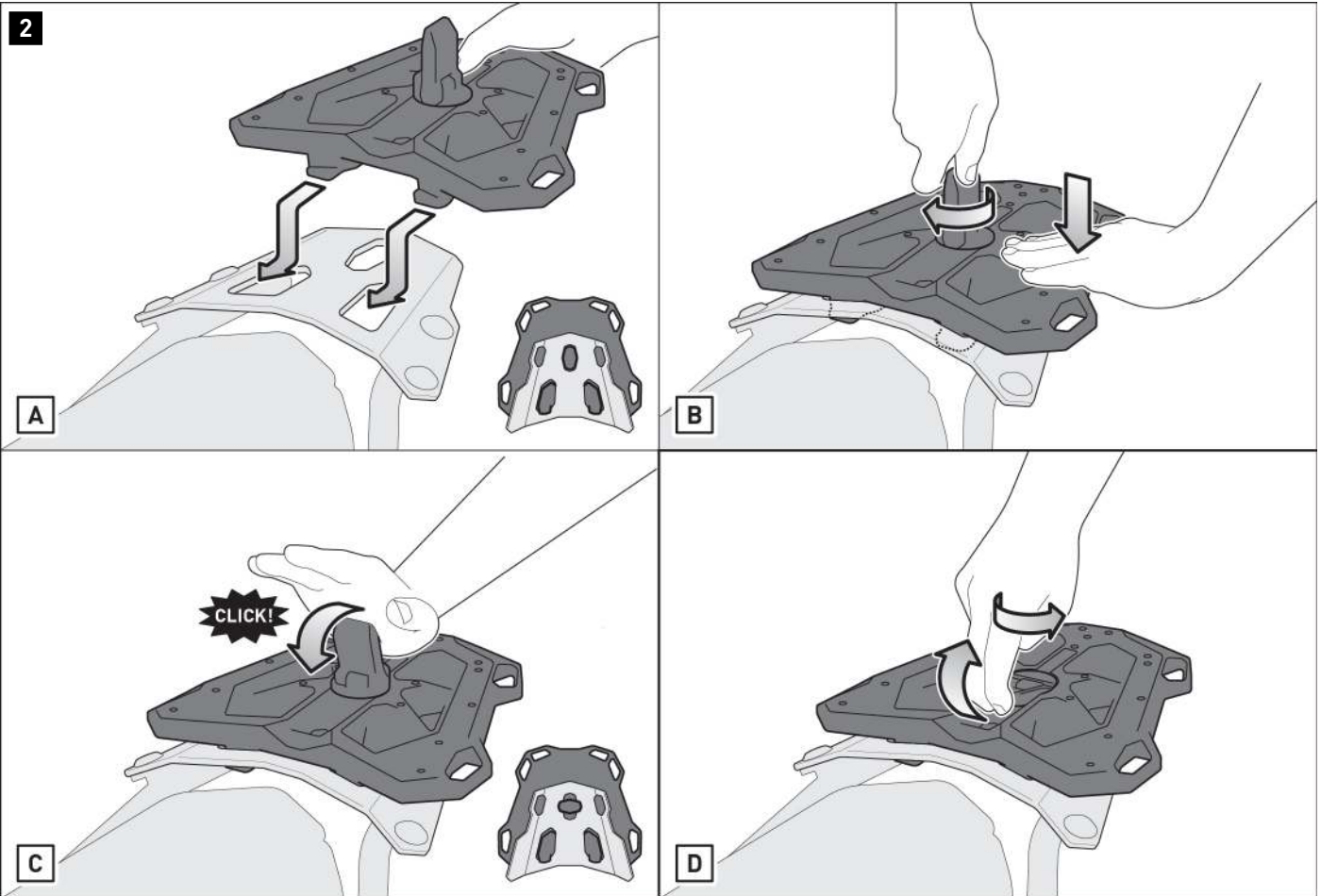

Figure [A]: Slide the adapter plate (1) with the two hooks into the openings of your STREET-RACK (sold separately).

Figure [B]: Gently press down on the adapter plate (1) and turn the latch buckle 90 degrees until it locks into place.

Figure [C]: Finally, press the latch buckle down firmly.

Figure [D]: To **loosen** the adapter plate (1), simply pull the latch buckle up and turn it to its original position.

PRODUCT-SPECIFIC NOTES

⚠ NOTE: *Observe the country-specific regulations for the registration/operation of your vehicle or applicable TÜV regulations. After assembly, have parts that are subject to registration entered in the vehicle documents by your test centre.*

Item number: **HSK.00.745.11000/B**

Revision: **03** · Date: **09 - 2023**

DUSC L

 ~ 0.25 h.

EASY      DIFFICULT

ENGLISH Thank you for choosing this premium product from SW-MOTECH. Visit our online shop for more information (e.g. model assignments). Required documents (e.g. national type approval) are available there for you to download.

Please read and understand all the instructions, safety information and warnings in these mounting instructions before mounting and using the product in order to avoid injury and damage. Keep these mounting instructions for reference.

This product was developed for vehicles in factory condition. Compatibility with original accessories or accessories from other manufacturers cannot be guaranteed.

These mounting instructions have been prepared to the best of our current knowledge. No legal claims relating to accuracy can be made. Errors and omissions excepted. We reserve the right to make technical and design changes. The copyright is held by SW-MOTECH.

SAFETY WARNING SYMBOL

 This warning symbol is used in these mounting instructions to warn of deadly dangers, injuries or other hazards. The words **DANGER**, **WARNING** or **CAUTION** are used as part of this warning symbol to convey important safety messages and information relating to the installation and use of this product. These words, together with the safety warning symbol, mean:

 **DANGER:** Indicates a hazardous situation which, if not avoided, will result in death or serious injury!

 **WARNING:** Indicates a hazardous situation which, if not avoided, may result in death or serious injury!

 **CAUTION:** Indicates a hazardous situation which, if not avoided, may result in minor or moderate injury!

 **NOTE:** Important information, but not relating to a risk of death or injury (property damage only)!

GENERAL INFORMATION

 **WARNING:** Assembly and/or maintenance of this product requires advanced technical skill, appropriate tools, and a good understanding of tool usage and torque specifications. For your own safety, SW-MOTECH recommends having the assembly and/or maintenance carried out by a qualified and certified motorcycle workshop.

 **WARNING:** If you do choose to assemble this product yourself, carefully and fully read the mounting instructions before assembly and use, and follow all instructions to avoid serious injury or death. Also observe all relevant information in the vehicle manual when mounting or using the product. IF YOU DO NOT UNDERSTAND ANY PART OF THESE MOUNTING INSTRUCTIONS OR NEED AN EXPLANATION AS TO A SPECIFIC INSTRUCTION, DO NOT ATTEMPT TO INSTALL THIS PRODUCT WITHOUT CONSULTING SW-MOTECH FOR ASSISTANCE!

PREPARATION: Read the mounting instructions carefully and make sure that all parts on the parts list are available.

 **CAUTION:** Ensure that your vehicle is standing securely. Switch off the engine and remove the ignition key. Allow the engine/exhaust to cool down if necessary. Disconnect the battery when working on the electrical system. Only use proper tools and always wear safety goggles and gloves during assembly and maintenance. Have a second person help you with assembly and maintenance.

ASSEMBLY: All parts and connections removed from the vehicle must be reinstalled according to the vehicle manufacturer's specifications or replaced with parts and hardware supplied by SW-MOTECH.

 **WARNING:** Secure all threads with a medium-strength liquid threadlocker, unless otherwise specified.

 **DANGER:** Tightening torques not defined by SW-MOTECH must be obtained from the vehicle manufacturer or a certified motorbike workshop.

FUNCTIONAL CHECK: After mounting the product, ensure that no moving parts are obstructed and that the function of the vehicle is not impeded. Cables and hoses must not rub against each other and/or be hindered in any way.

 **WARNING:** Carry out a comprehensive functionality check before you start to drive. Check the tightening torque of all connections and the tight fit of the product after the first 50 km and then at regular intervals. Mounted accessories can change the handling and stability of the vehicle.



SW-MOTECH GmbH & Co. KG
Ernteweg 7-10
35282 Rauschenberg
Germany



 info@sw-motech.com
 www.sw-motech.com

LEGEND OVERVIEW - READ AND KEEP MOUNTING INSTRUCTIONS!



Take note of the symbols and what they mean in the ASSEMBLY section. If the term OEM appears in the ASSEMBLY section, the vehicle manufacturer's specifications must be observed and applied.



If you have any questions, please don't hesitate to contact our Customer Service team or our distributors. You can find our telephone number and a list of our distributors in our online shop:
www.sw-motech.com



Do not use thread lock: Indicates that no liquid thread lock should be used at this point.



Tighten by hand: Indicates that the attachment must be carefully tightened by hand.

PARTS LIST - READ AND KEEP MOUNTING INSTRUCTIONS!

1

1



HSK.00.745.80000/B

 **1/1**

2

2



HSK.00.745.027.02

 **2/2**

3

3



HSK.00.745.047.02

 **1/1**

4



4 x 10; WN 1452
SC.ST.040.010.48.1452.109

 **2/2**

5



T20
TRX.T20

 **1/1**



- ⚠ **WARNING: Always wear eye and hand protection!**
- ⚠ **WARNING: Always use the proper tools!**

Opening the lid

- 1.1 - Press the DUSC release button (1) and pull the lid latch buckle to the open position.
- 1.2 - Remove the latch buckle from the corresponding bracket and open the lid.



2



Installing the lid limiter

2.1 - Place the lid limiters (2) with the large openings on the mushroom-shaped supports provided

⚠ NOTE: Pay attention to the proper use of the DUSC (1): **top case** or **side case**. Fasten the lid limiters (2) to the respective mushroom-shaped DUSC (1).

2.2 - Pull the lid limiters (2) into fixed position.

⚠ NOTE: Before closing the lid for the first time, the lid limiters (2) must be slightly compressed. When closing the lid, make sure that the lid limiters (2) are not trapped between the lid and the case body.



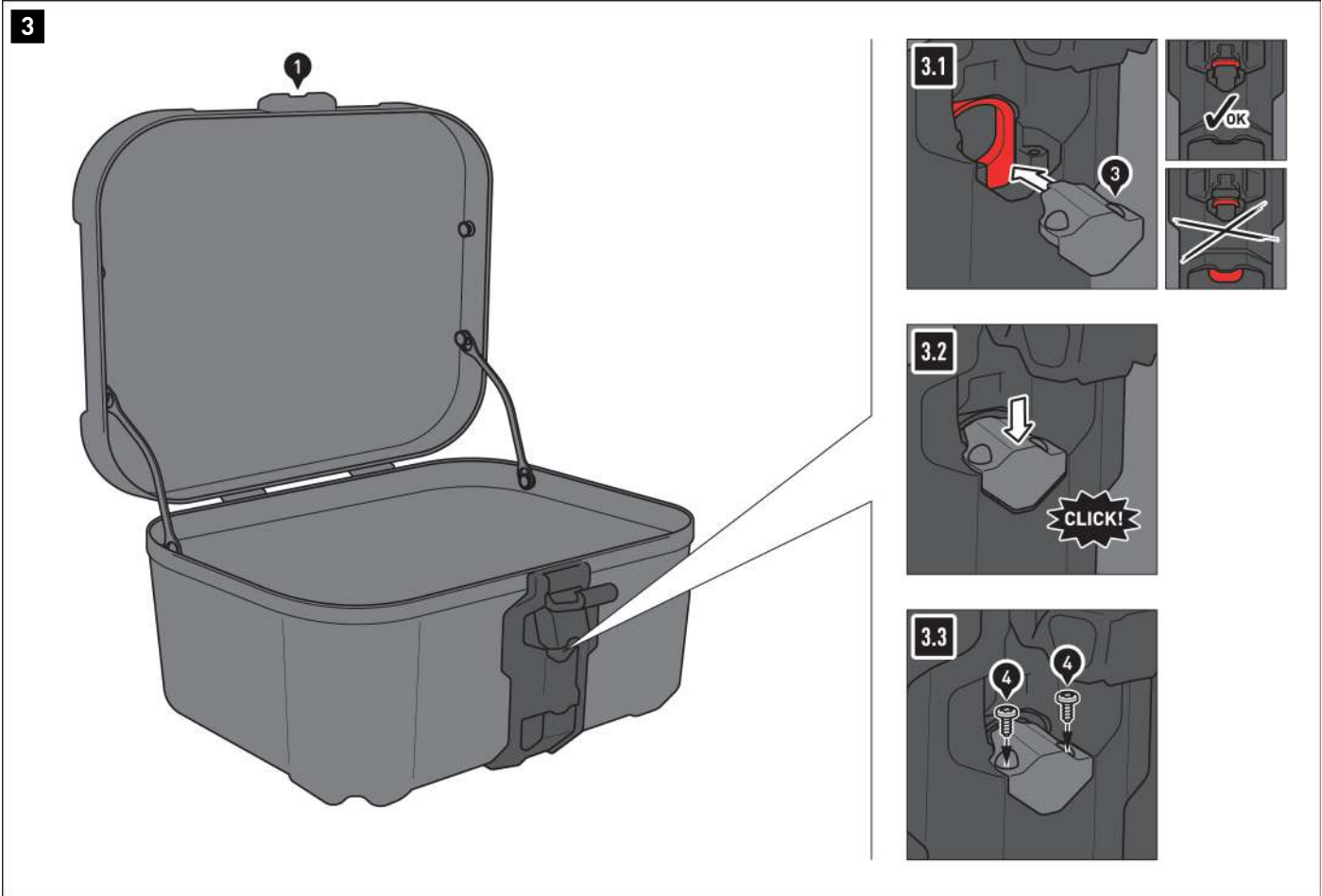

Installing lock casing connector

⚠ NOTE: If you have opted for the DUSC lock set, this step is not necessary. Install the lock set instead.

3.1 - Open the DUSC latch buckle (1) and position the latch housing connector (3) as shown.

⚠ NOTE: Make sure the locking tab is in the unlocked (up) position. If necessary, the locking tab must be pushed up into the unlocked position.

3.2 - Push the latch housing connector (3) down until it clicks into place.

3.3 - Screw in the latch housing connector (3) using the screws (4) and the torx key (5). Carefully tighten the screws by hand.

⚠ WARNING: Over-tightening the screws may damage the lock casing!

⚠ NOTE: Ensure that the locking mechanism is in working order!

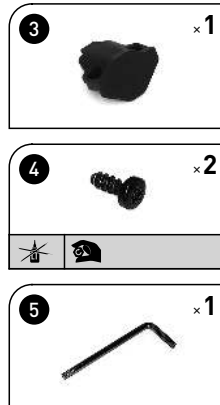

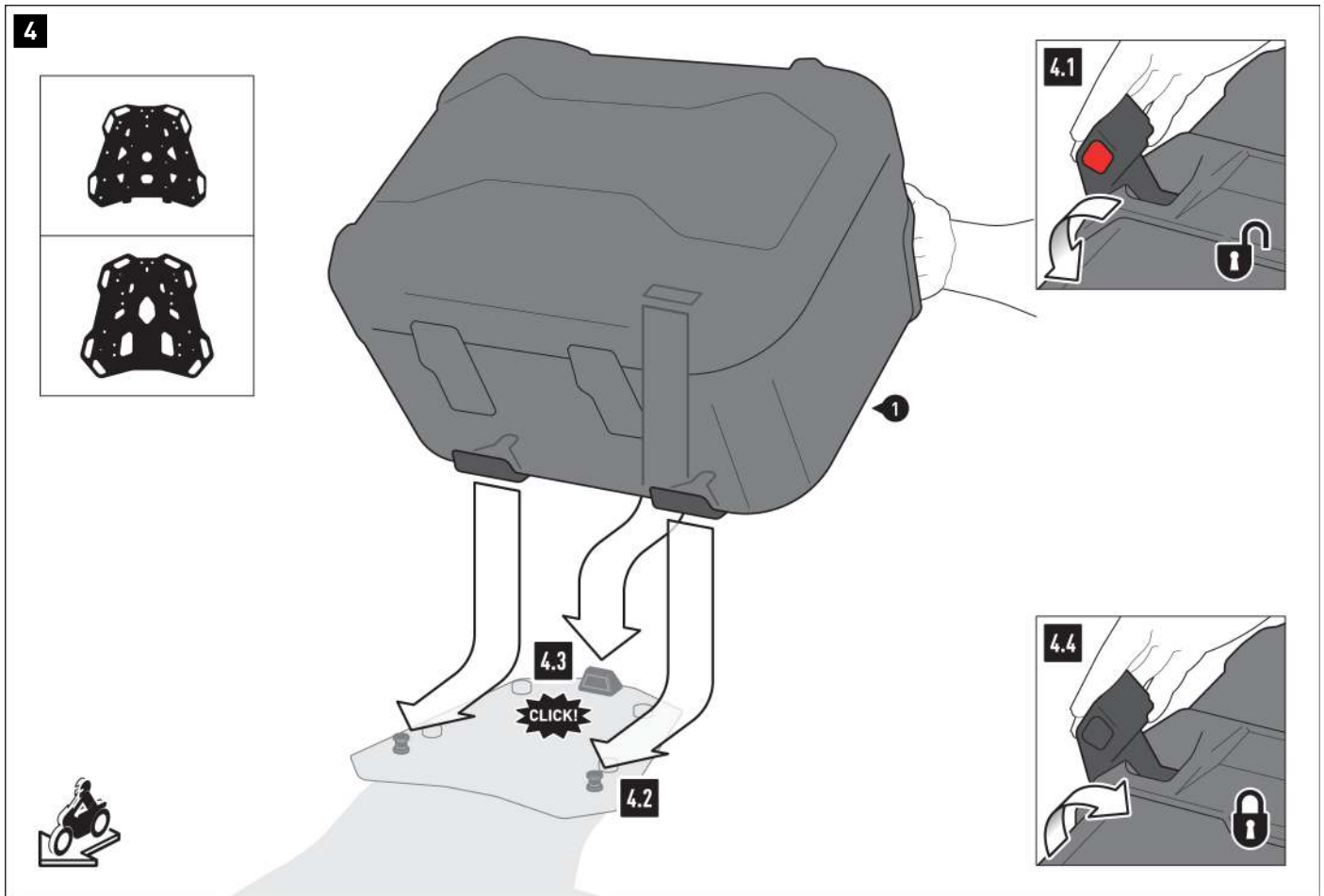

Attaching the DUSC to a top case

4.1 - Press the DUSC release button (1) and pull the fastening system latch buckle to the open position.

4.2 - Press the DUSC (1) with the two locking openings onto the mushroom-shaped supports of your SW-MOTECH rack.

4.3 - Press the DUSC (1) with the locking opening onto the locking lug of your SW-MOTECH rack.

▲ WARNING: You should be able to hear a clicking sound!

4.4 - Press the system latch buckle to closed position.

▲ WARNING: Ensure the DUSC is firmly positioned!

▲ WARNING: Make sure that no components of the DUSC (1) can come into contact with any hot and moving parts on the vehicle!

Also ensure that all components are at least 5 cm away from hot parts as well as hot gas coming from the exhaust!

After assembly, make sure that this distance is maintained in all vehicle positions!

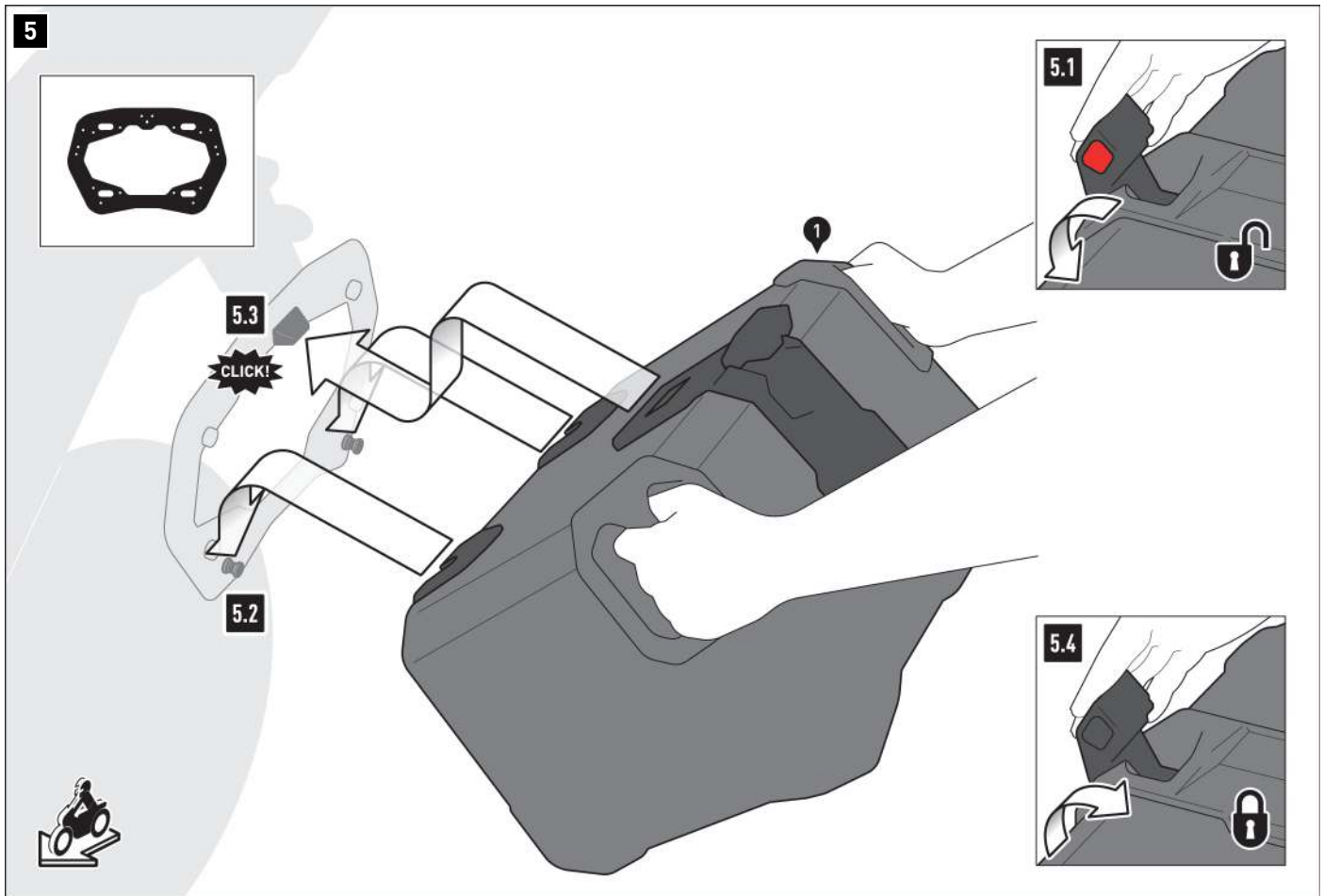

Attaching the DUSC to a side case

5.1 - Press the DUSC release button (1) and pull the system latch buckle to the open position.

5.2 - Press the DUSC (1) with the two locking openings onto the mushroom-shaped supports of your SW-MOTECH side carrier.

5.3 - Press the DUSC (1) with the locking opening onto the locking lug of your SW-MOTECH side carrier.

▲ WARNING: You should be able to hear a clicking sound!

5.4 - Press the system latch buckle to closed position.

▲ WARNING: Ensure the DUSC is firmly positioned!

▲ WARNING: Make sure that no components of the DUSC (1) can come into contact with any hot and moving parts on the vehicle!

Also ensure that all components are at least 5 cm away from hot parts as well as hot gas coming from the exhaust!

After assembly, make sure that this distance is maintained in all vehicle positions!

6

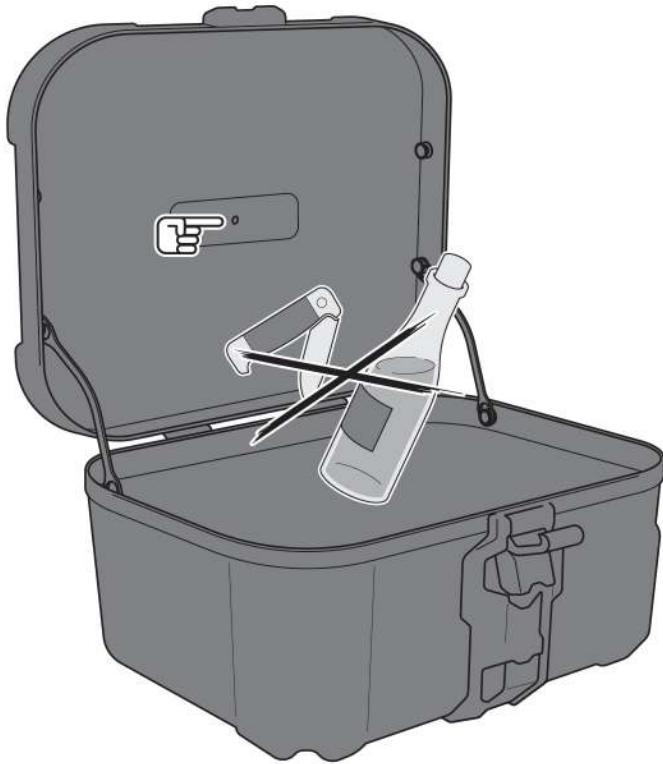

Loading

⚠ WARNING: Ensure that the load is evenly distributed! Ensure that the load will not slip while driving!

⚠ NOTE: Make sure never to store sharp-edged, pointed or similar objects that could cause personal injury or damage to the vehicle/DUSC! Be particularly careful not to damage the overpressure membrane built into the lid!

Care

Use ONLY a soft textile brush, cloth or sponge and warm soapy water for cleaning! Then rinse with clean water.

Do NOT use any harsh cleaning agents, utensils or pressure washer! Be sure to clean the DUSC after winter driving to avoid salt damage.

⚠ NOTE: Surface materials may be subject to fluctuations in color (fading) in the event of prolonged and intensive exposure to sunlight and the elements (e.g. smog, acid rain, etc.)! SW-MOTECH is not responsible for this type of wear!

PRODUCT-SPECIFIC NOTES

⚠ NOTE: Observe the country-specific regulations for registering/operating your vehicle or the applicable TÜV regulations. After assembly, have parts that are subject to registration entered in the vehicle documents by your test centre.

⚠ DANGER: Carry out a comprehensive function check before driving!

⚠ DANGER: Check that the product is properly positioned before departure and at every rest stop (every 200 km)!

⚠ DANGER: The driving/braking behavior of the motorcycle changes noticeably after the attachment of this product!

⚠ DANGER: Lean angle and ground clearance may be restricted by this product!

⚠ DANGER: The maximum vehicle load defined by the vehicle manufacturer may NOT be exceeded.

The maximum permissible load of the SW-MOTECH rack/side rack may NOT be exceeded; make sure to take into account the dead weight of the product.

Dead weight of DUSC M: 3.9 kg (8.6 lbs)

Dead weight of DUSC L: 4.1 kg (9 lbs)

Payload when used as a top case:

 ≤ 5 kg (≤ 11 lbs)	 ≤ 130km/h (≤ 80mph)
---	---

Payload when used as a side case:

 ≤ 10KG (≤ 22 lbs)	 ≤ 130km/h (≤ 80mph)
---	---

Item number: **LOC.00.745.10100**

Revision: **00** · Date: **08 - 2023**

Hard case lock set

 ~ 0.25 h.

EASY      DIFFICULT

ENGLISH Thank you for choosing this premium product from SW-MOTECH. Visit our online shop for more information (e.g. model assignments). Required documents (e.g. national type approval) are available there for you to download.

Please read and understand all the instructions, safety information and warnings in these mounting instructions before mounting and using the product in order to avoid injury and damage. Keep these mounting instructions for reference.

This product was developed for vehicles in factory condition. Compatibility with original accessories or accessories from other manufacturers cannot be guaranteed.

These mounting instructions have been prepared to the best of our current knowledge. No legal claims relating to accuracy can be made. Errors and omissions excepted. We reserve the right to make technical and design changes. The copyright is held by SW-MOTECH.

SAFETY WARNING SYMBOL

 This warning symbol is used in these mounting instructions to warn of deadly dangers, injuries or other hazards. The words **DANGER**, **WARNING** or **CAUTION** are used as part of this warning symbol to convey important safety messages and information relating to the installation and use of this product. These words, together with the safety warning symbol, mean:

 **DANGER:** Indicates a hazardous situation which, if not avoided, will result in death or serious injury!

 **WARNING:** Indicates a hazardous situation which, if not avoided, may result in death or serious injury!

 **CAUTION:** Indicates a hazardous situation which, if not avoided, may result in minor or moderate injury!

 **NOTE:** Important information, but not relating to a risk of death or injury (property damage only)!

GENERAL INFORMATION

 **WARNING:** Assembly and/or maintenance of this product requires advanced technical skill, appropriate tools, and a good understanding of tool usage and torque specifications. For your own safety, SW-MOTECH recommends having the assembly and/or maintenance carried out by a qualified and certified motorcycle workshop.

 **WARNING:** If you do choose to assemble this product yourself, carefully and fully read the mounting instructions before assembly and use, and follow all instructions to avoid serious injury or death. Also observe all relevant information in the vehicle manual when mounting or using the product. IF YOU DO NOT UNDERSTAND ANY PART OF THESE MOUNTING INSTRUCTIONS OR NEED AN EXPLANATION AS TO A SPECIFIC INSTRUCTION, DO NOT ATTEMPT TO INSTALL THIS PRODUCT WITHOUT CONSULTING SW-MOTECH FOR ASSISTANCE!

PREPARATION: Read the mounting instructions carefully and make sure that all parts on the parts list are available.

 **CAUTION:** Ensure that your vehicle is standing securely. Switch off the engine and remove the ignition key. Allow the engine/exhaust to cool down if necessary. Disconnect the battery when working on the electrical system. Only use proper tools and always wear safety goggles and gloves during assembly and maintenance. Have a second person help you with assembly and maintenance.

ASSEMBLY: All parts and connections removed from the vehicle must be reinstalled according to the vehicle manufacturer's specifications or replaced with parts and hardware supplied by SW-MOTECH.

 **WARNING:** Secure all threads with a medium-strength liquid threadlocker, unless otherwise specified.

 **DANGER:** Tightening torques not defined by SW-MOTECH must be obtained from the vehicle manufacturer or a certified motorbike workshop.

FUNCTIONAL CHECK: After mounting the product, ensure that no moving parts are obstructed and that the function of the vehicle is not impeded. Cables and hoses must not rub against each other and/or be hindered in any way.

 **WARNING:** Carry out a comprehensive functionality check before you start to drive. Check the tightening torque of all connections and the tight fit of the product after the first 50 km and then at regular intervals. Mounted accessories can change the handling and stability of the vehicle.



SW-MOTECH GmbH & Co. KG
Ernteweg 7-10
35282 Rauschenberg
Germany



 info@sw-motech.com
 www.sw-motech.com



Take note of the symbols and what they mean in the ASSEMBLY section. If the term OEM appears in the ASSEMBLY section, the vehicle manufacturer's specifications must be observed and applied.



If you have any questions, please don't hesitate to contact our Customer Service team or our distributors. You can find our telephone number and a list of our distributors in our online shop:

www.sw-motech.com

PARTS LIST - READ AND KEEP MOUNTING INSTRUCTIONS!

2

1



HSK.00.745.500.04

 **3/3**

2



T20
TRX.T20

 **1/1**

3



ALK.00.165.A63

 **2/2**

3

3



ALK.00.165.562.01

 **1/1**

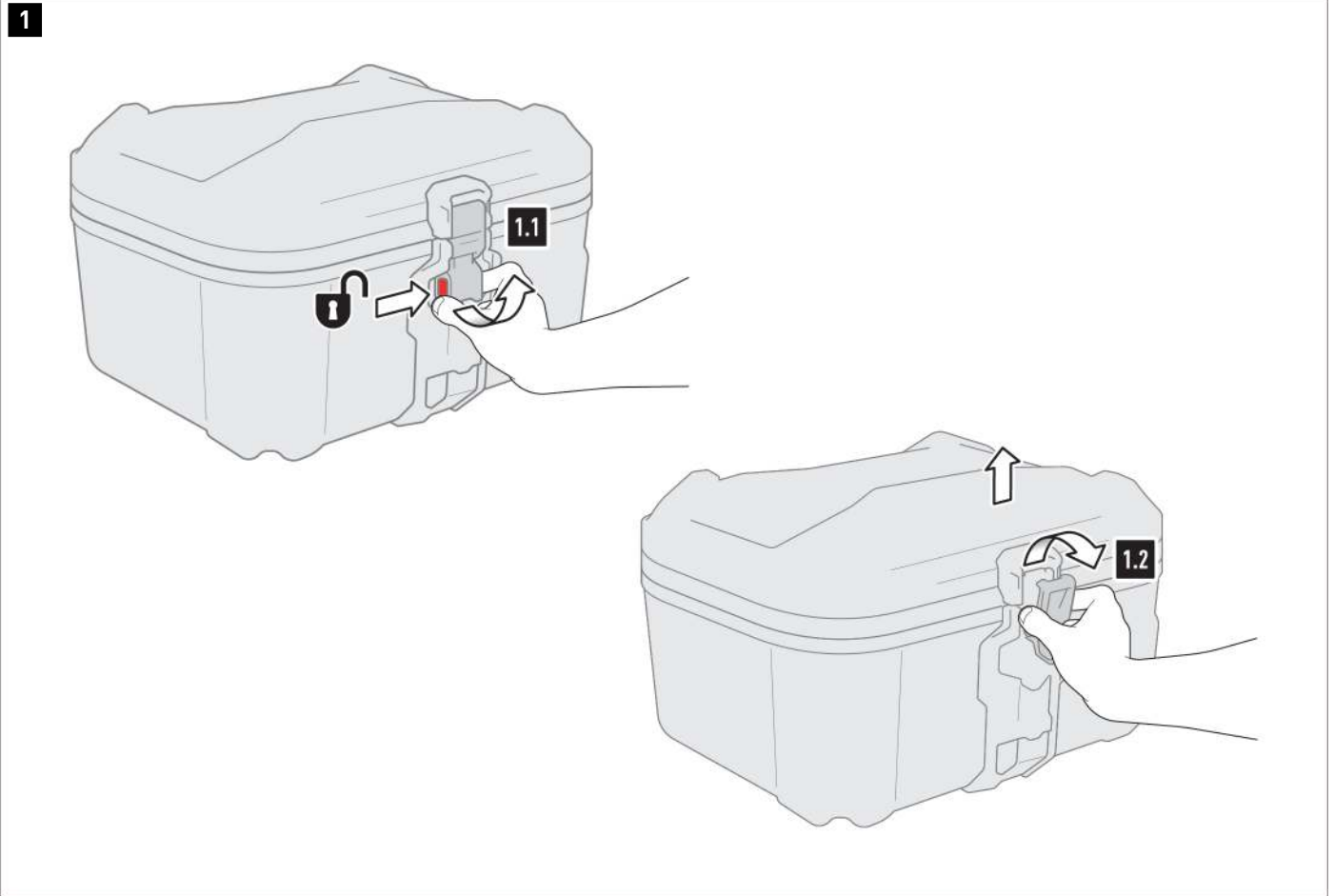

⚠ WARNING: Always wear eye and hand protection!
⚠ WARNING: Always use the proper tools!

Opening the lid

1.1 - Press the DUSC release button (*) and pull the lid latch buckle into the open position.

1.2 - Remove the latch buckle from the corresponding bracket and open the lid.



2

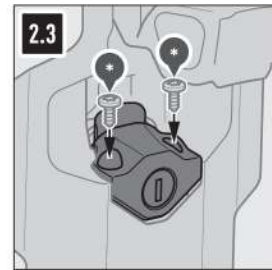
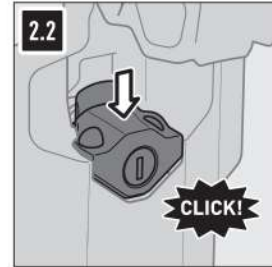
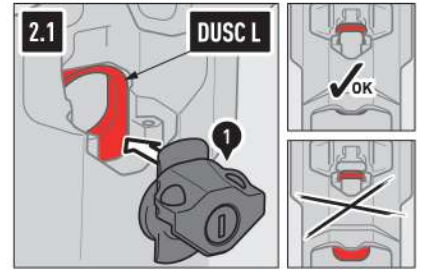

Install DUSC lock

2.1 - Open the DUSC (*) latch buckle and position the lock (1) as shown.
 ⚠ **NOTE: DUSC L ONLY:** Make sure the locking tab (highlighted in red) is in the unlocked position (up)! If necessary, the locking tab must be pushed up into the unlocked position!

2.2 - Push the lock (1) down until it clicks into place.

2.3 - Screw in the lock (1) using the screws (*) supplied with the DUSC and the torx key (2). Carefully tighten the screws by hand.

⚠ **WARNING: Over-tightening the screws may damage the lock casing!**

⚠ **NOTE:** Ensure that the locking mechanism is in working order!

⚠ **NOTE:** NEVER lubricate the lock cylinder with oil! Only use graphite powder!

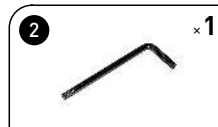

3



Install toolbox lock

3.1 - Insert the lock (4) with the sealing ring (*) supplied with the toolbox in the lock hole of the cover. Secure the lock (4) on the inside with the safety clip (4)



⚠ NOTE: NEVER lubricate the lock cylinder with oil! Only use graphite powder!

PRODUCT-SPECIFIC NOTES

⚠ NOTE: *Observe the country-specific regulations for the registration/operation of your vehicle or applicable TÜV regulations. After assembly, have parts that are subject to registration entered in the vehicle documents by your test centre.*